

COLORstrip

COLORstrip Mini

Quick Reference Guide

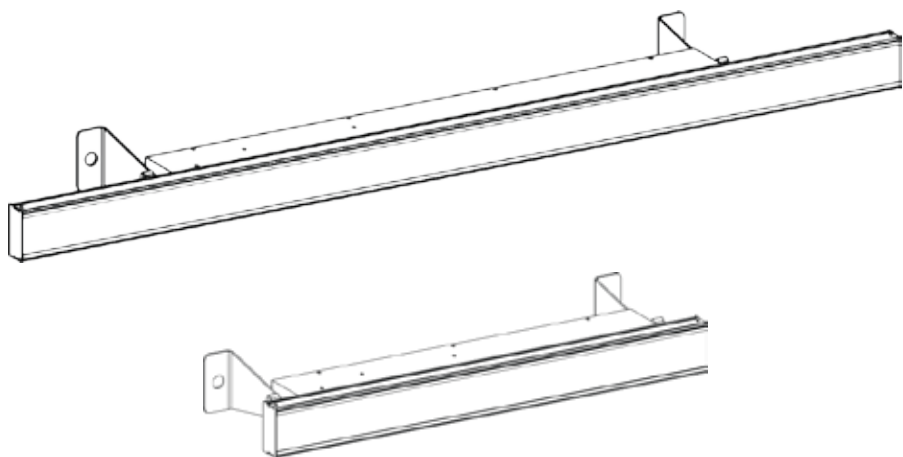

CHAUVET®

About This Guide The COLORstrip/COLORstrip Mini Quick Reference Guide (QRG) has basic product information such as mounting, menu options, and DMX values. Download the User Manual from www.chauvetlighting.com for more details.

Disclaimer The information and specifications contained in this QRG are subject to change without notice.

Safety Notes These Safety Notes include important information about installation, use, and maintenance.



- This product is not intended for permanent installation.
- ONLY connect this product to a grounded and protected circuit.
- Always disconnect from power before cleaning or replacing the fuse.
- DO NOT look at the light source when the product is on.
- Make sure the power cord is not crimped or damaged.
- Never disconnect this product from power by pulling on the cord.
- When mounting this product overhead, use a safety cable.
- DO NOT allow flammable materials close to the unit while operating.
- DO NOT touch this product when it is operating because it may be hot.



- The voltage of the outlet to which you are connecting this product must be within the range stated on the decal or rear panel of the product.
- This product is for indoor use only! (IP20) To prevent risk of fire or shock, do not expose this product to rain or moisture.
- Always mount this product in a location with adequate ventilation, at least 20 in (50 cm) from adjacent surfaces.
- Be sure that no ventilation slots on the unit’s housing are blocked.
- Never connect this product to a dimmer or rheostat.
- Replace the fuse with the same type and rating.
- ONLY use the hanging/mounting bracket or the handles to carry this product.
- The maximum ambient temperature is 104 °F (40 °C). Do not operate this product at higher temperatures.
- In the event of a serious operating problem, stop using immediately.
- DO NOT open this product. It contains no user-serviceable parts.
- To eliminate unnecessary wear and improve its lifespan, during periods of non-use completely disconnect the product from the power via breaker or by unplugging it.

Contact Outside the U.S., United Kingdom, Ireland, Mexico, or Benelux contact your distributor to request support or return a product. Visit www.chauvetlighting.com for contact information.

- What Is Included**
- COLORstrip
 - or
 - COLORstrip Mini
 - Power Cord
 - L-Brackets with Mounting Hardware
 - Warranty Card
 - Quick Reference Guide

To Begin Unpack your COLORstrip/COLORstrip Mini and make sure you have received all parts in good condition. If the box or contents appear damaged, notify the carrier immediately, not Chauvet.

Product Description The COLORstrip/COLORstrip Mini is a compact, multicolor strip light for use in indoor mobile entertainment applications. The COLORstrip/COLORstrip Mini is perfect as a wash light or effect light when paired with other COLORstrip products. Built-in infrared technology offers wireless control with the optional Infrared Remote Control (IRC-6) from CHAUVET DJ.

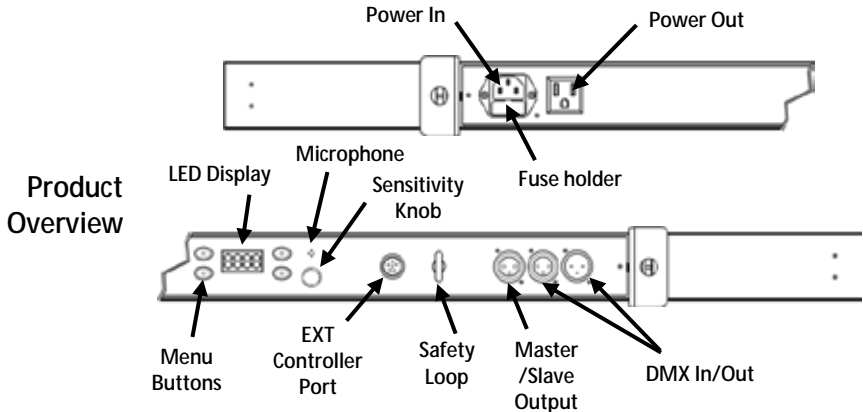

AC Power This product has an auto-ranging power supply that can work with an input voltage range of 100–240 VAC, 50/60 Hz.



Power Linking

To eliminate wear and improve its lifespan, during periods of non-use completely disconnect from power via breaker or by unplugging it.

For the maximum number of COLORstrip/COLORstrip Mini that can be power linked at 120 V or at 240 V, see the User Manual or the label on the product.

Fuse Replacement

1. Disconnect the product from power.
2. Wedge the tip of a flat-head screwdriver into the slot of the fuse holder.
3. Pry the safety cap out of the housing.
4. Remove the blown fuse from the clip on the front of the safety cap and replace with a fuse of the exact same type and rating.
5. Re-insert the fuse holder and reconnect power.



Upon plugging in the product, allow up to 30 seconds start-up time.

Mounting Before mounting this product, read the [Safety Notes](#).

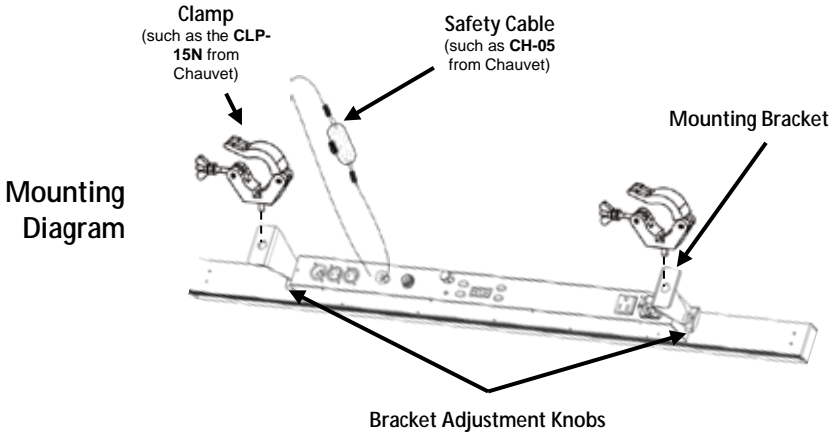

Control Panel Description	Button	Function
	<MODE>	Exits from the current menu or function
	<ENTER>	Enables the currently displayed menu or sets the currently selected value into the selected function
	<UP>	Navigates upwards through the menu list and increases the numeric value when in a function
	<DOWN>	Navigates downwards through the menu list and decreases the numeric value when in a function

DMX Linking The COLORstrip/COLORstrip Mini can work with a DMX controller when linked by DMX serial connections. Instructions for connecting and configuring this product for DMX operation are in the User Manual. If you are not familiar with DMX, download the DMX Primer from www.chauvetlighting.com.

Starting Address To ensure full access to all channels in each DMX mode, the highest recommended DMX address is **509**.

After setting the starting DMX address, press <MODE>, then <ENTER> to save the address to the product’s memory.

Master/Slave Connection The COLORstrip/COLORstrip Mini uses the DMX data connection for its Master/Slave mode. Instructions for connecting and configuring this product for Master/Slave operation are in the User Manual.

Master/Slave Runway Mode The COLORstrip/COLORstrip Mini uses the Master/Slave output for its Runway mode. Instructions for connecting and configuring this product for Runway mode operation are in the User Manual.

Menu Options

Main Level	Programming Levels				Description	
Act	A000				Blackout	
	A001		F000–F100		Red (strobe)	
	A002		F000–F100		Green (strobe)	
	A003		F000–F100		Blue (strobe)	
	A004		F000–F100		Yellow (strobe)	
	A005		F000–F100		Purple (strobe)	
	A006		F000–F100		Cyan (strobe)	
	A007		F000–F100		White (strobe)	
	A008		P000–P100	F000–F100		Color Chase 1 (speed, strobe)
	A009		P000–P100	F000–F100		Color Chase 2 (speed, strobe)
	A010		P000–P100	F000–F100		Color Chase 3 (speed, strobe)
	A011		P000–P100	F000–F100		Color Chase 4 (speed, strobe)
	A012		P000–P100			Color Chase 5 (speed)
	A013		P000–P100			Color Chase 6 (speed)
	A014		P000–P100			Color Chase 7 (speed)
	A015		P000–P100			Color Chase 8 (speed)
	A016		P000–P100			Color Chase 9 (speed)
	A017		P000–P100			Color Chase 10 (speed)
	A018		P000–P100			Color Chase 11 (speed)
	A019		P000–P100			Color Chase 12 (speed)
A020		P000–P100			Color Chase 13 (speed)	
A021	r000–r100	G000–G100	b000–b100	F000–F100	Color Mix (red, green, blue, strobe)	
A022		P000–P100			Color fade (speed)	
A023					All Color Chases 1–13 (speed)	
SYS	SdAd		001– 509		DMX Address	
	SAAAd				Reset	













To save the current mode to the product’s memory, press <MODE>, then <ENTER>. The saved mode will be active upon start-up.























IRC-6 Remote (Infrared Remote Control)







The COLORstrip/COLORstrip Mini is compatible with the IRC-6 remote from Chauvet.

The following IRC-6 buttons are used with the COLORstrip/COLORstrip Mini:

	Turns LEDs on/off
	Increases Speed (of Program or Strobe) or color value
	Decreases Speed (of Program or Strobe) or color value
	Enables Strobe setting
	Enables Color Mixing
	Sets Red color value
	Sets Green color value
	Sets Blue color value
	Turns on Auto/Sound mode, or turns off Auto/Sound mode
	Turns on Auto/Sound mode, or turns off Auto/Sound mode

NOTE – If Auto/Sound mode is off, Static Color mode is on.

Static-Color Mode		Auto/Sound Mode	
	A007 (White)		A008
	A001 (Red)		A009
	A021 (Amber)		A010
	A004 (Yellow)		A011
	A002 (Green)		A012
	A006 (Cyan)		A013
	A003 (Blue)		A014
	A005 (Purple)		A015
	A021 (Pink)		A017
	A021 (Sunflower)		A023
	No function		A022 (No response to sound)

-        - No function with this product
- The default for Static Color mode is **A007** (white).
- The default for Auto/Sound mode is **A008**.

DMX Values

4 Channels	Channel	Function	Value	Percent/Setting
1	Static Colors		000 ó 009	No function
			010 ó 119	Red 0–100%
			020 ó 029	Green 0–100%
			030 ó 039	Blue 0–100%
			040 ó 049	Yellow 0–100%
			050 ó 059	Magenta 0–100%
			060 ó 069	Cyan 0–100%
			070 ó 079	White 0–100%
	Color Chases		080 ó 089	Color Chase 1
			090 ó 099	Color Chase 2
			100 ó 109	Color Chase 3
			110 ó 119	Color Chase 4
			120 ó 129	Color Chase 5
			130 ó 139	Color Chase 6
			140 ó 149	Color Chase 7
			150 ó 159	Color Chase 8
			160 ó 169	Color Chase 9
			170 ó 179	Color Chase 10
			180 ó 189	Color Chase 11
			190 ó 199	Color Chase 12
	200 ó 209	Color Chase 13		
	RGB Color Mixing	210 ó 219	Channels 2–4	
	Color Fade	220 ó 229	Color Fade	
	Sound-Active	230 ó 255	Sound-Active	
2	Run Speed (when Ch. 1 is 080–209)	000 ó 127	Slow to fast	
		128 ó 255	Sound-Active	
	Red (when Ch. 1 is 210–219)	000 ó 255	0–100%	
	Fade Speed (when Ch. 1 is 220–229)	000 ó 255	Slow to fast	
3	Strobe (when Ch. 1 is 010–119)	000 ó 249	Slow to fast	
		250 ó 255	Sound-Active	
	Green (when Ch. 1 is 210–219)	000 ó 255	0–100%	
4	Blue (when Ch. 1 is 210–219)	000 ó 255	0–100%	

Acerca de esta guía

La Guía de referencia rápida (GRR) del COLORstrip/COLORstrip Mini contiene información básica sobre el producto, como montaje, opciones de menú y valores DMX. Descargue el manual de usuario de www.chauvetlighting.com para una información más detallada.

Exención de responsabilidad

La información y especificaciones contenidas en esta GRR están sujetas a cambio sin previo aviso.

Notas de seguridad

Estas notas de seguridad incluyen información importante sobre el montaje, uso y mantenimiento.



- Este producto no está concebido para una instalación permanente.
- Conecte este producto SOLO a un circuito con toma de tierra y protegido.
- Desconecte siempre de la alimentación antes de la limpieza o sustitución del fusible.
- NO mire a la fuente de luz cuando el producto esté encendido.
- Asegúrese de que el cable de alimentación no está retorcido ni estropeado.
- Nunca desconecte este producto de la alimentación tirando del cable.
- Cuando monte este producto en alto, use un cable de seguridad.
- NO permita la presencia de materiales inflamables cerca de la unidad cuando esté en funcionamiento.
- NO toque este producto cuando esté en funcionamiento, pues podría estar caliente.



- La tensión del enchufe al que conecte este producto ha de estar en el rango establecido en el grabado o en el panel posterior del producto.
- ¡Este producto es para uso en interiores solamente! (IP20) Para evitar riesgos de incendio o descarga, no exponga este producto a la lluvia o la humedad.
- Monte siempre este producto en una ubicación con ventilación adecuada, al menos a 20 in (50 cm) de superficies adyacentes.
- Asegúrese de que ninguna ranura de ventilación en la carcasa de la unidad queda bloqueada.
- Nunca conecte este producto a un atenuador o 8eóstato.
- Sustituya el fusible con uno del mismo tipo y categoría.
- Use SOLAMENTE los soportes de colgar/montar o las asas para mover este producto.
- La temperatura ambiente máxima es de 104 °F (40 °C). No haga funcionar este producto a temperaturas más altas.
- En caso de un problema grave de funcionamiento, deje de usarlo inmediatamente.
- NO abra este producto. No contiene piezas reparables por el usuario.
- Para evitar un desgaste innecesario y alargar su vida útil, desconecte completamente el producto mediante el interruptor o desenchufándolo durante periodos en que no se use.

Contacto

Fuera de EE. UU., Reino Unido, Irlanda, México o Benelux póngase en contacto con su distribuidor para solicitar asistencia o devolver un producto. Visite www.chauvetlighting.com para información de contacto.

Qué va incluido

- COLORstrip
- Soportes en L con Material de Montaje
- COLORstrip Mini
- Tarjeta de garantía
- Cable de alimentación
- Guía de referencia rápida

Para empezar

Desembale su COLORstrip/COLORstrip Mini y asegúrese de que ha recibido todas las partes en buen estado. Si la caja o los componentes parecen dañados, notifíquese lo inmediatamente al transportista, no a Chauvet.

Descripción del producto

El COLORstrip/COLORstrip Mini es una banda de luz multicolor para utilizarse en aplicaciones móviles de espectáculos en interiores. El COLORstrip/COLORstrip Mini es perfecto como baño de luz o luz de efecto en combinación con otro COLORstrip productos. La tecnología de infrarrojos integrada le ofrece control sin cables con el mando a distancia por infrarrojos (IRC-6) opcional de CHAUVET DJ.

Vista general

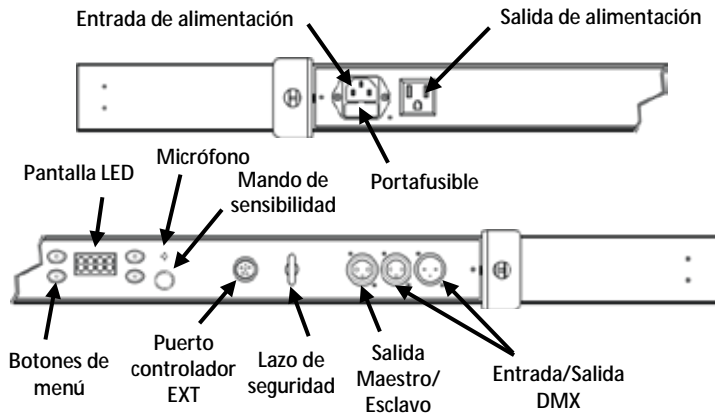

Corriente alterna

Este producto tiene una fuente de alimentación con detección automática que puede funcionar con un rango de tensión de entrada de 100–240 VCA, 50/60 Hz.



Para evitar un desgaste innecesario y alargar su vida útil, desconecte completamente el producto mediante el interruptor o desenchufándolo durante periodos en que no se use.

Alimentación en cadena

Para ver el máximo número de productos COLORstrip/COLORstrip Mini que se pueden alimentar en cadena, consulte el Manual de usuario o la pegatina del producto.

Sustitución del fusible

1. Desconecte el producto de la alimentación.
2. Haga cuña con la punta de un destornillador plano en la ranura del portafusibles.
3. Saque la tapa de seguridad de la carcasa.
4. Quite el fusible fundido de la sujeción en la parte frontal de la tapa de seguridad y sustituya el fusible con otro del mismo tipo y categoría.
5. Vuelva a insertar el portafusibles y conecte de nuevo la alimentación.



Una vez conectado el producto, el tiempo de puesta en marcha puede ser de hasta 30 segundos.

Montaje Antes de montar este producto, lea las [Notas de seguridad](#).

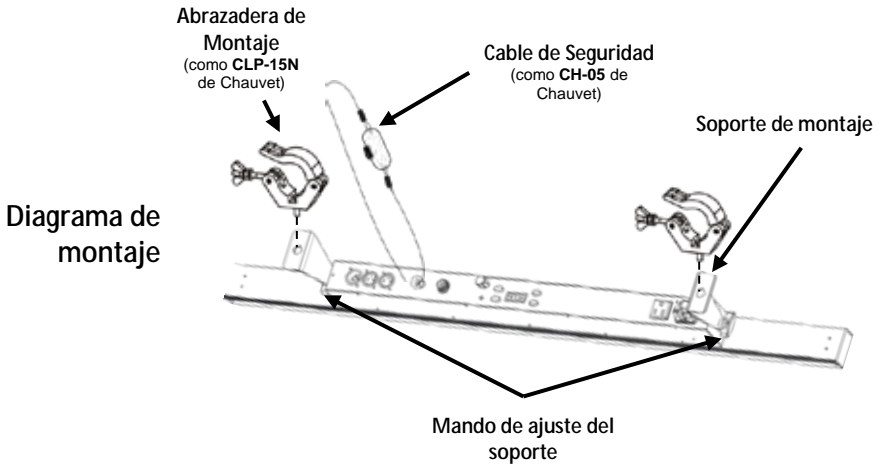

Descripción del panel de control	Botón	Función
	<MODE>	Salte del menú o función actual
	<ENTER>	Activa una opción de menú o valor seleccionado
	<UP>	Se desplaza hacia arriba por la lista de menú o aumenta el valor numérico cuando está en una función
	<DOWN>	Se desplaza hacia abajo por la lista de menú o disminuye el valor numérico cuando está en una función

Enlace DMX El COLORstrip/COLORstrip Mini puede funcionar con un controlador DMX cuando se enlaza por conexiones serie DMX. Las instrucciones para conectar y configurar este producto para funcionamiento DMX están en el Manual de usuario. Si no está familiarizado con DMX, descargue el Manual DMX de www.chauvetlighting.com.

Dirección de inicio Para asegurarse acceso total a todos los canales en cada modo DMX, la dirección DMX más recomendable es **509**.

Después de configurar la dirección DMX de inicio, pulse <MODE> y luego <ENTER> para guardar la dirección en la memoria del producto.

Conexión Maestro/Esclavo El COLORstrip/COLORstrip Mini usa la conexión de datos DMX para su modo Maestro/Esclavo. Las instrucciones para conectar y configurar este producto para funcionamiento Maestro/Esclavo están en el Manual de usuario.

Modo Runway Maestro/Esclavo El COLORstrip/COLORstrip Mini utiliza la salida Maestro/Esclavo para su modo Runway. Las instrucciones para conectar y configurar este producto para el modo Runway están en el Manual de usuario.

Menu Opciones











Nivel Principal	Niveles de Programación				Descripción	
ACT	A000				Blackout	
	A001		F000–F100		Rojo (estroboscopio)	
	A002		F000–F100		Verde (estroboscopio)	
	A003		F000–F100		Azul (estroboscopio)	
	A004		F000–F100		Amarillo (estroboscopio)	
	A005		F000–F100		Morado (estroboscopio)	
	A006		F000–F100		Cian (estroboscopio)	
	A007		F000–F100		Blanco estroboscopio)	
	A008	P000–P100	F000–F100		Secuencia de color 1 (velocidad, estroboscopio)	
	A009	P000–P100	F000–F100		Secuencia de color 2 (velocidad, estroboscopio)	
	A010	P000–P100	F000–F100		Secuencia de color 3 (velocidad, estroboscopio)	
	A011	P000–P100	F000–F100		Secuencia de color 4 (velocidad, estroboscopio)	
	A012		P000–P100		Secuencia de color 5 (velocidad)	
	A013		P000–P100		Secuencia de color 6 (velocidad)	
	A014		P000–P100		Secuencia de color 7 (velocidad)	
	A015		P000–P100		Secuencia de color 8 (velocidad)	
	A016		P000–P100		Secuencia de color 9 (velocidad)	
	A017		P000–P100		Secuencia de color 10 (velocidad)	
	A018		P000–P100		Secuencia de color 11 (velocidad)	
	A019		P000–P100		Secuencia de color 12 (velocidad)	
	A020		P000–P100		Secuencia de color 13 (velocidad)	
	A021	r000–r100	G000–G100	b000–b100	F000–F100	Mezcla de color (rojo, verde, azul, estroboscopio)
	A022		P000–P100		Fade de color (velocidad)	
A023				Todas las secuencias de color 1–13 (velocidad)		
SYS	SdAd		001– 509		Dirección DMX	
	SAAd				Reinicio	



Para guardar el modo actual en la memoria del producto, pulse <MODE> y luego <ENTER>. El modo guardado se activará con la puesta en marcha.







Mando a distancia IRC-6 (control remoto por infrarrojos)

El COLORstrip/COLORstrip Mini es compatible con el mando a distancia IRC-6 de Chauvet. Los siguientes botones del IRC-6 se usan con el COLORstrip/COLORstrip Mini:

	Apaga/enciende los LED
	Aumenta la velocidad (del programa o estroboscopio) o el valor del color
	Disminuye la velocidad (del programa o estroboscopio) o el valor del color
	Activa la configuración del estroboscopio
	Activa la mezcla de color
	Establece el valor del rojo
	Establece el valor del verde
	Establece el valor del azul
	Enciende el modo Automático/Sonido o apaga el modo Automático/Sonido
	Enciende el modo Automático/Sonido o apaga el modo Automático/Sonido

NOTA: si el modo Automático/Sonido está apagado, el modo Color estático está encendido.

Modo Color estático		Modo Automático/Sonido	
	A007 (Blanco)		A008
	A001 (Rojo)		A009
	A021 (Ámbar)		A010
	A004 (Amarillo)		A011
	A002 (Verde)		A012
	A006 (Cian)		A013
	A003 (Azul)		A014
	A005 (Morado)		A015
	A021 (Rosa)		A017
	A021 (Girasol)		A023
	Sin función		A022 (sin respuesta al sonido)

-        - Sin función con este producto
- Para el modo Color estático el valor predeterminado es **A007** (blanco).
- Para el modo Automático/Sonido el valor predeterminado es **A008**.

Valores DMX

4 Canales	Canal	Función	Valor	Porcentaje/Configuración	
1	Colores estáticos		000 ó 009	Sin función	
			010 ó 019	Rojo 0–100%	
			020 ó 029	Verde 0–100%	
			030 ó 039	Azul 0–100%	
			040 ó 049	Amarillo 0–100%	
			050 ó 059	Magenta 0–100%	
			060 ó 069	Cian 0–100%	
			070 ó 079	Blanco 0–100%	
		Secuencias de color		080 ó 089	Secuencia de color 1
				090 ó 099	Secuencia de color 2
				100 ó 109	Secuencia de color 3
				110 ó 119	Secuencia de color 4
				120 ó 129	Secuencia de color 5
			130 ó 139	Secuencia de color 6	
			140 ó 149	Secuencia de color 7	
			150 ó 159	Secuencia de color 8	
			160 ó 169	Secuencia de color 9	
			170 ó 179	Secuencia de color 10	
		180 ó 189	Secuencia de color 11		
		190 ó 199	Secuencia de color 12		
	200 ó 209	Secuencia de color 13			
	Mezcla de color RGB	210 ó 219	Canales 2–4		
	Fade de color	220 ó 229	Fade de color		
	Activo por sonido	230 ó 255	Activo por sonido		
2	Velocidad de ejecución (cuando el C. 1 está entre 080–209)		000 ó 127	Lento a rápido	
			128 ó 255	Activo por sonido (y lento a rápido)	
	Rojo (cuando el C. 1 está entre 210–219)	000 ó 255	0–100%		
	Velocidad de fade (cuando el C. 1 está entre 220–229)	000 ó 255	Lento a rápido		
3	Estroboscopio (cuando el C. 1 está entre 010–119)		000 ó 249	Lento a rápido	
			250 ó 255	Activo por sonido	
	Verde (cuando el C. 1 está entre 210–219)	000 ó 255	0–100%		
4	Azul (cuando el C. 1 está entre 210–219)	000 ó 255	0–100%		

A propos de ce manuel Le Manuel de Référence (MR) du COLORstrip/COLORstrip Mini reprend des informations de base sur cet appareil notamment en matière de montage, d'options de menu et de valeurs DMX. Veuillez télécharger le manuel d'utilisation à partir du site internet www.chauvetlighting.com pour plus de détails.

Clause de non Responsabilité Les informations et caractéristiques contenues dans ce MR sont sujettes à modification sans préavis.

Consignes de Sécurité Ces consignes de sécurité contiennent des informations importantes en matière d'installation, d'utilisation et d'entretien.



- Cet appareil n'est pas adapté pour une installation permanente.
- Cet appareil DOIT être relié à un circuit mis à la terre et protégé.
- Toujours débrancher l'appareil de la source d'alimentation avant de le nettoyer ou de remplacer son fusible.
- NE PAS exposer directement les yeux à la source de lumière lorsque le produit est allumé.
- Veillez à ce que le cordon d'alimentation ne soit jamais pincé ou endommagé.
- Ne débranchez jamais cet appareil en tirant sur le cordon d'alimentation.
- En cas de montage de l'appareil en hauteur, veillez à toujours utiliser un câble de sécurité.
- NE PAS laisser de produit inflammable à proximité de l'appareil lorsque celui-ci fonctionne.
- NE PAS toucher au boîtier de l'appareil lorsqu'il est en fonctionnement, celui-ci pouvant être très chaud.



- La tension de la source d'énergie à laquelle est connecté cet appareil doit être dans la plage indiquée sur l'étiquette ou sur le panneau arrière de l'appareil.
- Cet appareil doit uniquement être utilisé en intérieur ! (IP20) Afin d'éviter tout risque d'incendie ou de décharge électrique, veillez à n'exposer cet appareil ni à la pluie ni à l'humidité.
- Installez toujours cet appareil dans un endroit bien ventilé à au moins 50 cm (20 po) des surfaces adjacentes.
- Assurez-vous qu'aucune fente de ventilation de l'appareil n'est obstruée.
- Ne connectez jamais cet appareil à un variateur ou un rhéostat.
- Lors du remplacement du fusible, utilisez le même type et le même ampérage.
- Utilisez EXCLUSIVEMENT le support de suspension/fixation pour soulever cet appareil.
- La température ambiante maximale est de 40 °C (104 °F). Ne faites pas fonctionner cet appareil à des températures plus élevées.
- En cas de sérieux problèmes de fonctionnement, arrêtez l'appareil immédiatement.
- NE PAS ouvrir cet appareil. Il ne contient aucune pièce réparable par l'utilisateur.
- Durant les périodes de non-utilisation, pour éviter toute usure inutile et pour prolonger la durée de vie, éteignez complètement l'appareil en le débranchant ou en coupant le disjoncteur.

Nous contacter En dehors des États-Unis, du Royaume-Uni, de l'Irlande, du Mexique ou du Benelux, contactez votre fournisseur si vous avez besoin d'assistance ou pour retourner un appareil. Veuillez consulter le site internet www.chauvetlighting.com pour obtenir des informations pour nous contacter.

- Contenu**
- COLORstrip
 - Supports en L avec Matériel de Montage
 - ou
 - COLORstrip Mini
 - Fiche de garantie
 - Cordon d'alimentation
 - Manuel de référence

Préalable Déballiez votre COLORstrip/COLORstrip Mini et assurez-vous que vous avez reçu toutes les pièces en bon état. Si la boîte et/ou son contenu semble endommagés, contactez immédiatement le transporteur, et non pas Chauvet.

Description de l'appareil

Le COLORstrip/COLORstrip Mini est une barre de lumières multicolores conçue pour les applications itinérantes de divertissement en intérieur. Le COLORstrip/COLORstrip Mini est parfait en tant que projecteur de type wash ou projecteur à effets couplé avec d'autres appareils COLORstrip. La technologie infrarouge intégrée permet un contrôle sans fil avec la télécommande infrarouge (IRC-6) disponible en option auprès de CHAUVET DJ.

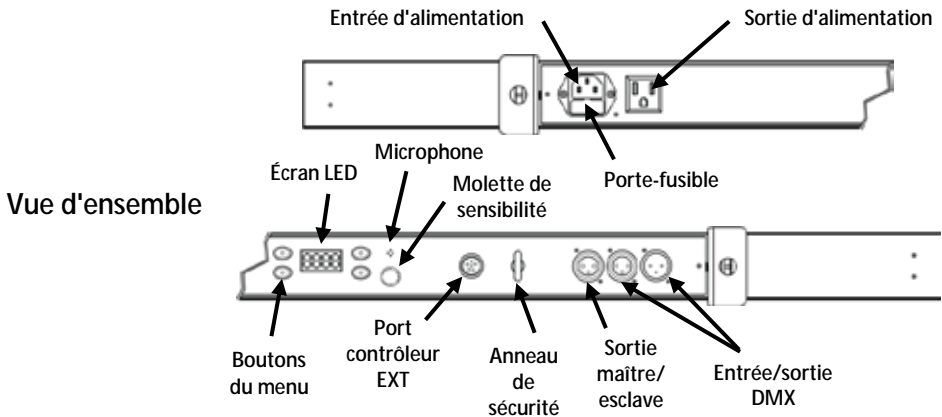

Alimentation
CA

Cet appareil est doté d'une alimentation universelle qui peut prendre en charge toute tension d'entrée comprise entre 100 et 240 VCA, 50/60 Hz.



Durant les périodes de non-utilisation, pour éviter toute usure inutile et pour prolonger la durée de vie, éteignez complètement l'appareil en le débranchant ou en coupant le disjoncteur.

Chainage électrique

Pour savoir combien d'appareils COLORstrip/COLORstrip Mini USB peuvent être chaînés au maximum selon le voltage, veuillez consulter le manuel de l'utilisateur ou l'autocollant apposé sur l'appareil.

Remplacement des fusibles

1. Débranchez l'appareil
2. Calez la pointe d'un tournevis à tête plate dans la fente du porte-fusible.
3. Soulevez le capuchon de sécurité hors du boîtier.
4. Enlevez le fusible grillé logé dans le clip sur le devant du capuchon de sécurité et remplacez-le par un fusible de même type et de même ampérage.
5. Remettez le porte-fusible en place puis rebranchez.



Laissez l'appareil démarrer pendant au moins 30 secondes après l'avoir branché.

Montage Avant de monter cet appareil, veuillez lire les [Consignes de Sécurité](#).

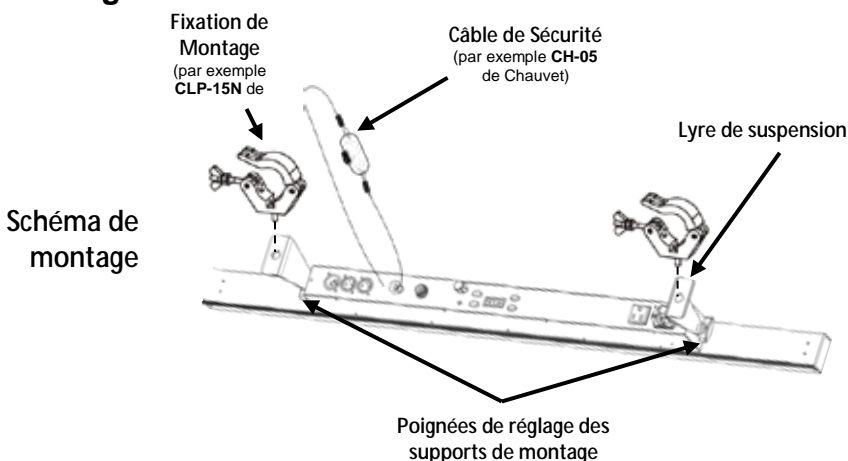

Description du panneau de commande

Bouton	Fonction
<MODE>	Permet de sortir du menu ou de la fonction en cours
<ENTER>	Permet d'activer une option de menu ou une valeur sélectionnée
<UP>	Permet de naviguer vers le haut dans la liste du menu ou d'incrémenter une valeur numérique dans une fonction
<DOWN>	Permet de naviguer vers le bas dans la liste du menu ou de décrémenter une valeur numérique dans une fonction

Chaînage DMX

Le COLORstrip/COLORstrip Mini peut fonctionner avec un contrôleur DMX lorsqu'il est relié par des connexions séries DMX. Les instructions pour la connexion et la configuration de cet appareil pour le fonctionnement en DMX sont indiquées dans le manuel d'utilisation. Si vous n'êtes pas familier avec le protocole DMX, vous pouvez télécharger l'introduction au DMX à l'adresse www.chauvetlighting.com.

Adresse de départ

Pour permettre un accès à l'ensemble des canaux de chaque mode DMX, l'adresse DMX maximale recommandée est **509**.

Après avoir paramétré l'adresse DMX de départ, appuyez sur <MODE> puis <ENTER> pour sauvegarder l'adresse dans la mémoire de l'appareil.

Connexion maître/esclave

Le COLORstrip/COLORstrip Mini utilise une connexion de données DMX pour le fonctionnement de son mode maître/esclave. Les instructions pour la connexion et la configuration de cet appareil pour le fonctionnement en maître/esclave sont indiquées dans le manuel d'utilisation.

Mode piste maître/esclave

Le COLORstrip/COLORstrip Mini utilise la sortie maître/esclave pour son mode piste. Les instructions pour la connexion et la configuration de cet appareil pour le fonctionnement en mode piste maître/esclave sont indiquées dans le manuel d'utilisation.

Options du Menu











Niveau Principal	Niveaux de programmation				Description	
	A000				Noir général	
	A001	F000–F100			Rouge (stroboscope)	
	A002	F000–F100			Vert (stroboscope)	
	A003	F000–F100			Bleu (stroboscope)	
	A004	F000–F100			Jaune (stroboscope)	
	A005	F000–F100			Violet (stroboscope)	
	A006	F000–F100			Cyan (stroboscope)	
	A007	F000–F100			Blanc (stroboscope)	
	A008	P000–P100	F000–F100		Chenillard de couleur 1 (vitesse, stroboscope)	
	A009	P000–P100	F000–F100		Chenillard de couleur 2 (vitesse, stroboscope)	
	A010	P000–P100	F000–F100		Chenillard de couleur 3 (vitesse, stroboscope)	
ACt	A011	P000–P100	F000–F100		Chenillard de couleur 4 (vitesse, stroboscope)	
	A012	P000–P100			Chenillard de couleur 5 (vitesse)	
	A013	P000–P100			Chenillard de couleur 6 (vitesse)	
	A014	P000–P100			Chenillard de couleur 7 (vitesse)	
	A015	P000–P100			Chenillard de couleur 8 (vitesse)	
	A016	P000–P100			Chenillard de couleur 9 (vitesse)	
	A017	P000–P100			Chenillard de couleur 10 (vitesse)	
	A018	P000–P100			Chenillard de couleur 11 (vitesse)	
	A019	P000–P100			Chenillard de couleur 12 (vitesse)	
	A020	P000–P100			Chenillard de couleur 13 (vitesse)	
	A021	r000–r100	G000–G100	b000–b100	F000–F100	Mélange de couleur (rouge, vert, bleu, stroboscope)
	A022	P000–P100			Fondu de couleur (vitesse)	
	A023				Tous les chenillards de couleur 1–13 (vitesse)	
SYS	SdAd		001– 509		Adresse DMX	
	SAAd				Réinitialisation	

























Pour enregistrer le mode courant dans la mémoire de l'appareil, appuyez sur <MODE> puis <ENTER>. Le mode sauvegardé sera activé lors du démarrage.







Télécommande IRC-6 (Télécommande par infrarouge)

Le COLORstrip/COLORstrip Mini est compatible avec la télécommande IRC-6 de Chauvet.
Les boutons suivants de l'IRC 6 sont utilisés avec le COLORstrip/COLORstrip Mini.

-  Activer ou désactiver les LEDs
-  Augmente la vitesse (du programme ou du stroboscope) ou la valeur de couleur
-  Diminue la vitesse (du programme ou du stroboscope) ou la valeur de couleur
-  Active le paramétrage de stroboscope
-  Active le mélange de couleur
-  Permet de définir la valeur de couleur rouge
-  Permet de définir la valeur de couleur vert
-  Permet de définir la valeur de couleur bleu
-  Permet de basculer le mode Auto/Activation par le son
-  Permet de basculer le mode Auto/Activation par le son

REMARQUE - Si le mode Auto/Activation par le son est désactivé, le mode couleur statique est activé.

Mode couleur statique		Mode auto/activation par le son	
	A007 (blanc)		A008
	A001 (rouge)		A009
	A021 (ambre)		A010
	A004 (jaune)		A011
	A002 (vert)		A012
	A006 (cyan)		A013
	A003 (bleu)		A014
	A005 (violet)		A015
	A021 (rose)		A017
	A021 (tournesol)		A023
	Aucune fonction		A022 (aucune réponse au son)

-        - Aucune fonction pour cet appareil.
- Le réglage par défaut pour le mode couleur statique est **A007** (blanc).
- Le réglage par défaut pour le mode auto/activation par le son est **A008**.

Valeurs DMX

4 Canaux	Canal	Fonction	Valeur	Pourcentage/Paramétrage	
1	Couleurs statiques		000 ∘ 009	Aucune fonction	
			010 ∘ 019	Rouge 0–100%	
			020 ∘ 029	Vert 0–100%	
			030 ∘ 039	Bleu 0–100%	
			040 ∘ 049	Jaune 0–100%	
			050 ∘ 059	Magenta 0–100%	
			060 ∘ 069	Cyan 0–100%	
			070 ∘ 079	Blanc 0–100%	
		Chenillards de couleur		080 ∘ 089	Chenillard de couleur 1
				090 ∘ 099	Chenillard de couleur 2
				100 ∘ 109	Chenillard de couleur 3
				110 ∘ 119	Chenillard de couleur 4
				120 ∘ 129	Chenillard de couleur 5
			130 ∘ 139	Chenillard de couleur 6	
			140 ∘ 149	Chenillard de couleur 7	
			150 ∘ 159	Chenillard de couleur 8	
			160 ∘ 169	Chenillard de couleur 9	
			170 ∘ 179	Chenillard de couleur 10	
		180 ∘ 189	Chenillard de couleur 11		
		190 ∘ 199	Chenillard de couleur 12		
		200 ∘ 209	Chenillard de couleur 13		
		Mélange de couleur RGB	210 ∘ 219	Canaux 2 à 4	
		Fondu de couleur	220 ∘ 229	Fondu de couleur	
	Activation par le son	230 ∘ 255	Activation par le son		
2	Vitesse d'exécution (lorsque le canal 1 est dans l'intervalle 080–209)		000 ∘ 127	Lent à rapide	
			128 ∘ 255	Activation par le son (et lent à rapide)	
	Rouge (lorsque le canal 1 est dans l'intervalle 210–219)	000 ∘ 255	0–100%		
	Vitesse de fondu (lorsque le canal 1 est dans l'intervalle 220–229)	000 ∘ 255	Lent à rapide		
3	Stroboscope (lorsque le canal 1 est dans l'intervalle 010–119)		000 ∘ 249	Lent à rapide	
			250 ∘ 255	Activation par le son	
	Vert (lorsque le canal 1 est dans l'intervalle 210–219)	000 ∘ 255	0–100%		
4	Bleu (lorsque le canal 1 est dans l'intervalle 210–219)	000 ∘ 255	0–100%		

Über diese Schnellanleitung

In der Schnellanleitung des COLORstrip/COLORstrip Mini finden Sie die wesentlichen Produktinformationen, wie etwa über die Montage, Menüoptionen und DMX-Werte des Geräts. Laden Sie für weiterführende Informationen unter www.chauvetlighting.com das Benutzerhandbuch herunter.

Haftungsausschluss

Die in dieser Anleitung aufgeführten Informationen und Spezifikationen können ohne vorherige Ankündigung geändert werden.

Sicherheitshinweise

Diese Sicherheitshinweise enthalten wichtige Informationen über die Montage, Verwendung und Wartung des Geräts.



- Dieses Produkt eignet sich nicht für eine permanente Installation.
- Schließen Sie dieses Produkt NUR an einen mit der Erde verbundenen und geschützten Stromkreis an.
- Trennen Sie das Gerät von der Stromquelle, bevor Sie es reinigen oder die Sicherung auswechseln.
- NIEMALS in die Lichtquelle schauen, während das Gerät eingeschaltet ist.
- Stellen Sie sicher, dass das Netzkabel nicht gequetscht oder beschädigt ist.
- Ziehen Sie beim Trennen des Geräts von der Stromversorgung nie am Kabel.
- Bei Montage über Kopf immer ein Sicherungsseil verwenden.
- KEINE entflammaren Materialien während des Betriebs in der Nähe des Geräts lagern.
- NIEMALS während des Betriebs das Gehäuse berühren, da dies sehr heiß wird.



- Die Spannung der Schukosteckdose, an die Sie das Gerät anschließen, muss sich innerhalb des Spannungsbereiches befinden, der auf dem Hinweisschild oder dem rückwärtigen Bedienfeld des Geräts angegeben ist.
- Dieses Gerät darf nur im Innenbereich verwendet werden. (IP20) Um das Risiko von Bränden oder elektrischen Schlägen zu vermeiden, dürfen Sie das Gerät nicht Regen oder Feuchtigkeit aussetzen.
- Installieren Sie das Gerät an einem Ort mit ausreichender Belüftung und mit einem Abstand von 50 cm zu den angrenzenden Flächen.
- Stellen Sie sicher, dass die Lüftungsöffnungen im Gehäuse des Geräts nicht verschlossen sind.
- Schließen Sie dieses Gerät niemals an einen Dimmer oder Regelwiderstand an.
- Achten Sie beim Auswechseln der Sicherung darauf, den gleichen Typ mit den gleichen Werten zu verwenden.
- Das Gerät NUR an den Hänge-/Befestigungsbügeln oder Griffen tragen.
- Die maximal zulässige Umgebungstemperatur beträgt 40 °C. Nehmen Sie das Gerät nicht bei höheren Temperaturen in Betrieb.
- Bei ernsthaften Betriebsproblemen stoppen Sie umgehend die Verwendung des Geräts.
- Dieses Gerät NICHT öffnen. Die eingebauten Komponenten sind für den Kunden wartungsfrei.
- Um unnötigen Verschleiß zu vermeiden und die Lebensdauer des Geräts zu verlängern, trennen Sie während längerer Perioden des Nichtgebrauchs das Gerät vom Stromnetz – entweder per Trennschalter oder durch Herausziehen des Steckers aus der Steckdose.

Kontakt Kunden außerhalb der USA, GB, Irland, Mexiko oder der Benelux-Staaten wenden sich an ihren Lieferanten, um den Kundensupport in Anspruch zu nehmen oder ein Produkt zurückzuschicken. Kontaktinformationen finden Sie unter www.chauvetlighting.com.

Packungsinhalt

- COLORstrip
- L-Winkel mit Befestigungsmaterial
- oder
- Garantiekarte
- COLORstrip Mini
- Schnellanleitung
- Netzkabel

Start Packen Sie Ihren COLORstrip/COLORstrip Mini aus und überprüfen Sie, ob Sie alle Teile unbeschädigt erhalten haben. Wenn die Verpackung beschädigt ist, benachrichtigen Sie umgehend das Transportunternehmen, nicht jedoch Chauvet.

Produktbeschreibung Die COLORstrip/COLORstrip Mini ist eine kompakte, für den Innenbereich konzipierte, mehrfarbige Leistenleuchte für mobile Anwendungen im Unterhaltungsbereich. Die COLORstrip/COLORstrip Mini ist perfekt geeignet als Wash- oder Effektleuchte, wenn sie mit anderen COLORstrip-Produkten kombiniert wird. Die integrierte Infrarot-Technologie ermöglicht eine drahtlose Steuerung mit der optionalen IR-Fernbedienung (IRC-6) von CHAUVET DJ.

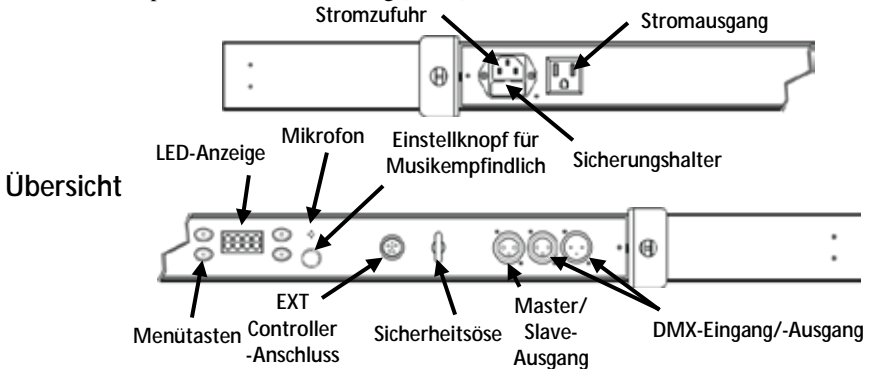

Wechselstrom Dieses Gerät verfügt über ein Vorschaltgerät, das automatisch die anliegende Spannung erkennt, sobald der Netzstecker in die Schukosteckdose gesteckt wird, und kann mit einer Eingangsspannung von 100~240 V AC, 50/60 Hz arbeiten.



Um unnötigen Verschleiß zu vermeiden und die Lebensdauer des Geräts zu verlängern, trennen Sie während längerer Perioden des Nichtgebrauchs das Gerät vom Stromnetz – entweder per Trennschalter oder durch Herausziehen des Steckers aus der Steckdose.

Serienschaltung der Geräte Informationen zur maximalen Anzahl der COLORpalette-Geräte, die in Serie geschaltet werden können, finden Sie in der Bedienungsanleitung oder auf dem Typenschild am Gerät.

- Auswechseln der Sicherung**
1. Trennen Sie das Gerät vom Stromnetz.
 2. Klemmen Sie die Spitze eines Flachkopfschraubendrehers in den Schlitz des Sicherungshalters.
 3. Hebeln Sie die Sicherheitsabdeckung vom Gehäuse ab.
 4. Entfernen Sie die durchgebrannte Sicherung von der Klemme am Vorderteil der Sicherheitsabdeckung, und ersetzen Sie diese durch eine Sicherung des gleichen Typs und mit den gleichen Werten.
 5. Stecken Sie den Sicherungshalter wieder zurück, und schließen Sie das Gerät an das Stromnetz an.



Warten Sie nach dem Anstecken des Geräts 30 Sekunden, damit es vollständig hochfahren kann.

Montage

Lesen Sie vor der Montage dieses Geräts in jedem Fall die [Sicherheitshinweise](#).

Befestigungsschelle
(wie die CLP-15N von Chauvet)

Sicherheitskabel
(wie die CH-05 von Chauvet)

Befestigungsbügel

Montageansicht

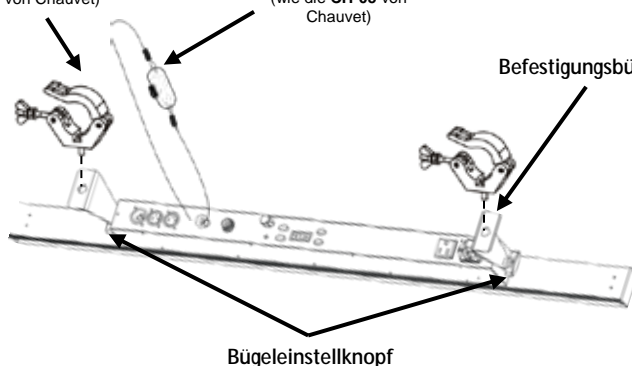

Beschreibung des Bedienfeldes

Taste	Funktion
<MODE>	Damit verlassen Sie das aktuelle Menü oder die Funktion
<ENTER>	Aktiviert eine Menüoption oder einen ausgewählten Wert
<UP>	Damit navigieren Sie durch die Menüpunkte nach oben und erhöhen den numerischen Wert der entsprechenden Funktionen
<DOWN>	Damit navigieren Sie durch die Menüpunkte nach unten und verringern den numerischen Wert der entsprechenden Funktionen

DMX-Verbindung

Der COLORstrip/COLORstrip Mini kann mit einem DMX-Controller betrieben werden, wenn eine DMX-Serienschaltung zum Einsatz kommt. Anweisungen zum Zusammenschluss und der Konfiguration dieses Geräts für den Betrieb im DMX-Modus finden Sie im Benutzerhandbuch. Wenn Sie mit DMX nicht vertraut sind, laden Sie "DMX - Eine Einführung" unter www.chauvetlighting.com herunter.

Startadresse

Um einen vollständigen Zugang zu allen Kanälen in jedem DMX-Modus zu gewährleisten, beträgt die höchste empfohlene DMX-Adresse **509**. Drücken Sie nach der Einstellung der Start-DMX-Adresse auf <MODE> und dann auf <ENTER>, um die Adresse im Gerät zu speichern.

Master/Slave-Schaltung

Der COLORstrip/COLORstrip Mini verwendet für seinen Master/Slave-Modus eine DMX-Datenverbindung. Anweisungen zum Zusammenschluss und der Konfiguration dieses Geräts für den Betrieb im Master/Slave-Modus finden Sie im Benutzerhandbuch.

Master/Slave Pistenfeuer-Modus

Die COLORstrip/COLORstrip Mini verwendet für ihren Master/Slave-Ausgang einen Pistenfeuer-Modus. Anweisungen zum Zusammenschluss und der Konfiguration dieses Geräts für den Betrieb im Pistenfeuer-Modus finden Sie im Benutzerhandbuch.

Menüoptionen











Hauptfunktion	Programmirebenen				Beschreibung
ACt	A000				Verdunkelung
	A001	F000–F100			Rot (Strobe)
	A002	F000–F100			Grün (Strobe)
	A003	F000–F100			Blau (Strobe)
	A004	F000–F100			Gelb (Strobe)
	A005	F000–F100			Lila (Strobe)
	A006	F000–F100			Kobaltblau (Strobe)
	A007	F000–F100			Weiß (Strobe)
	A008	P000–P100	F000–F100		Farb-Chase 1 (Geschwindigkeit, Strobe)
	A009	P000–P100	F000–F100		Farb-Chase 2 (Geschwindigkeit, Strobe)
	A010	P000–P100	F000–F100		Farb-Chase 3 (Geschwindigkeit, Strobe)
	A011	P000–P100	F000–F100		Farb-Chase 4 (Geschwindigkeit, Strobe)
	A012	P000–P100			Farb-Chase 5 (Geschwindigkeit)
	A013	P000–P100			Farb-Chase 6 (Geschwindigkeit)
	A014	P000–P100			Farb-Chase 7 (Geschwindigkeit)
	A015	P000–P100			Farb-Chase 8 (Geschwindigkeit)
	A016	P000–P100			Farb-Chase 9 (Geschwindigkeit)
	A017	P000–P100			Farb-Chase 10 (Geschwindigkeit)
	A018	P000–P100			Farb-Chase 11 (Geschwindigkeit)
	A019	P000–P100			Farb-Chase 12 (Geschwindigkeit)
A020	P000–P100			Farb-Chase 13 (Geschwindigkeit)	
A021	r000–r100	G000–G100	b000–b100	F000–F100	Farbmischung (rot, grün, blau, Strobe)
A022	P000–P100			Farb-Fade (Geschwindigkeit)	
A023				Alle Farb-Chases 1–13 (Geschwindigkeit)	
SYS	SdAd		001– 509		DMX-Adresse
	SAAd				Zurücksetzen

























Um den aktuellen Modus im Gerät zu speichern, drücken Sie auf <MODE> und dann auf <ENTER>. Der gespeicherte Modus ist beim Starten des Geräts aktiv.









IRC-6-Fernbedienung (Infrarot-Fernbedienung)

Der COLORstrip/COLORstrip Mini ist kompatibel mit der Infrarot-Fernbedienung (IRC-6) von Chauvet. Die folgenden Tasten der Fernbedienung IRC-6 werden für den COLORstrip/COLORstrip Mini verwendet:

-  Schaltet LEDs ein/aus
-  Erhöht die Geschwindigkeit (des Programms oder Strobe-Effekts) oder den Farbwert
-  Verringert die Geschwindigkeit (des Programms oder Strobe-Effekts) oder den Farbwert
-  Aktiviert Strobe-Einstellung
-  Aktiviert Farbmischung
-  Stellt den Farbwert Rot ein
-  Stellt den Farbwert Grün ein
-  Stellt den Farbwert Blau ein
-  Schaltet Auto-/Musiksteuerungs-Modus ein oder aus
-  Schaltet Auto-/Musiksteuerungs-Modus ein oder aus

HINWEIS – Wenn der Auto-/Musiksteuerungs-Modus ausgeschaltet ist, ist der statische Farb-Modus eingeschaltet.

Statischer Farb-Modus		Auto-/Musiksteuerungs-Modus	
 A007 (weiß)	 A008		
 A001 (rot)	 A009		
 A021 (bernsteinfarben)	 A010		
 A004 (gelb)	 A011		
 A002 (grün)	 A012		
 A006 (kobaltblau)	 A013		
 A003 (blau)	 A014		
 A005 (lila)	 A015		
 A021 (rosa)	 A017		
 A021 (sonnenblumenfarben)	 A023		
 Keine Funktion	 A022 (keine Reaktion auf Musik)		

-        - Keine Funktion mit diesem Produkt
-  Die Standardeinstellung für den statischen Farb-Modus ist **A007** (weiß).
-  Die Standardeinstellung für den Auto-/Musiksteuerungs-Modus ist **A008**.

DMX-Werte

4 Kanäle	Kanal	Funktion	Wert	Prozent/Einstellung	
1	Statischer Farben		000 ó 009	Keine Funktion	
			010 ó 019	Rot 0–100%	
			020 ó 029	Grün 0–100%	
			030 ó 039	Blau 0–100%	
			040 ó 049	Gelb 0–100%	
			050 ó 059	Magenta 0–100%	
			060 ó 069	Kobaltblau 0–100%	
			070 ó 079	Weiß 0–100%	
		Farb-Chases		080 ó 089	Farb-Chase 1
				090 ó 099	Farb-Chase 2
				100 ó 109	Farb-Chase 3
				110 ó 119	Farb-Chase 4
				120 ó 129	Farb-Chase 5
			130 ó 139	Farb-Chase 6	
			140 ó 149	Farb-Chase 7	
			150 ó 159	Farb-Chase 8	
			160 ó 169	Farb-Chase 9	
			170 ó 179	Farb-Chase 10	
		180 ó 189	Farb-Chase 11		
		190 ó 199	Farb-Chase 12		
	200 ó 209	Farb-Chase 13			
	RGB-Farbmischung	210 ó 219	Kanäle 2–4		
	Farb-Fade	220 ó 229	Farb-Fade		
	Musiksteuerung	230 ó 255	Musiksteuerung		
2	Ablaufgeschwindigkeit (wenn Kanal 1 von 080–209 reicht)	000 ó 127	Langsam nach schnell		
		128 ó 255	Musiksteuerung (und von langsam nach schnell)		
	Rot (wenn Kanal 1 von 210–219 reicht)	000 ó 255	0–100%		
	Fade-Geschwindigkeit (wenn Kanal 1 von 220–229 reicht)	000 ó 255	Langsam nach schnell		
3	Strobe (wenn Kanal 1 von 010–119 reicht)	000 ó 249	Langsam nach schnell		
		250 ó 255	Musiksteuerung		
	Grün (wenn Kanal 1 von 210–219 reicht)	000 ó 255	0–100%		
4	Blau (wenn Kanal 1 von 210–219 reicht)	000 ó 255	0–100%		

Informazioni sulla Guida

La Guida Rapida COLORstrip/COLORstrip Mini contiene informazioni di base sul prodotto quali montaggio, opzioni menù e valori DMX. Per maggiori dettagli, scaricare il Manuale Utente dal sito www.chauvetlighting.com

Esclusione di responsabilità

Le informazioni e le specifiche contenute in questa guida possono essere modificate senza preavviso.

Note di Sicurezza

Le Note di Sicurezza includono informazioni importanti circa il montaggio, l'uso e la manutenzione.



- Questa apparecchiatura non è progettata per installazione permanente.
- Collegare questa unità SOLTANTO ad un circuito dotato di messa a terra e protetto.
- Prima di effettuare la pulizia o sostituire il fusibile, scollegare sempre l'unità dall'alimentazione elettrica.
- NON guardare la sorgente luminosa quando l'unità è in funzione.
- Assicurarsi che il cavo di alimentazione non sia piegato o danneggiato.
- Non scollegare mai questa apparecchiatura dall'alimentazione elettrica tirando il cavo.
- Per il montaggio in alto dell'unità utilizzare SEMPRE un cavo di sicurezza.
- NON collocare materiale infiammabile vicino all'unità mentre è in funzione.
- NON toccare l'unità durante il funzionamento perché potrebbe essere molto calda.



- La tensione della presa a muro cui si collega l'apparecchiatura deve trovarsi entro il campo specificato sull'etichetta o sul pannello posteriore.
- Questa apparecchiatura deve essere utilizzata soltanto in interni (IP20)! Per evitare il rischio di incendio o di folgorazione non esporre l'apparecchiatura alla pioggia o all'umidità.
- Montare sempre l'unità in posizione ben ventilata, ad almeno 50 cm. (20") da qualsiasi superficie.
- Assicurarsi che nessuna apertura di ventilazione dell'unità sia ostruita.
- Non collegare mai ad un dimmer o ad un reostato
- Sostituire il fusibile con un altro dello stesso tipo e classe.
- Prendere e trasportare l'unità SOLTANTO dalla staffa per il montaggio sospeso o dalle maniglie.
- Massima temperatura ambiente ammessa: 40 °C (104 °F). Non utilizzare l'unità a temperature superiori.
- In caso di gravi problemi di funzionamento sospendere immediatamente l'utilizzo.
- NON aprire l'unità. Non contiene parti riparabili dall'utente.
- Per evitare un consumo inutile ed aumentare la durata, durante i periodi di non utilizzo disconnettere completamente il prodotto dall'alimentazione con l'interruttore o scollegando il cavo.

Contatti

Per richiedere assistenza o restituire l'apparecchiatura, al di fuori di Stati Uniti, Regno Unito, Irlanda, Messico o Benelux contattare il distributore locale. Per informazioni sui contatti, visitare il sito Web www.chauvetlighting.com.

Che cosa è incluso

- COLORstrip
- L-Staffa con Relativi Accessori
- Scheda di garanzia
- COLORstrip Mini
- Guida Rapida
- Cavo di alimentazione

Per iniziare

Disimballare COLORstrip/COLORstrip Mini ed accertarsi di aver ricevuto tutti i componenti integri. Se l'imballo appare danneggiato, farlo immediatamente presente al trasportatore e non a Chauvet.

Descrizione del prodotto

COLORstrip/COLORstrip Mini è una luce a striscia multicolore per interni e intrattenimento mobile. COLORstrip/COLORstrip Mini è perfetta come luce wash o effetto luminoso quando abbinata con altri COLORstrip unità. La tecnologia a infrarossi di cui è dotata offre la possibilità di controllo wireless con il telecomando a infrarossi (IRC-6) di CHAUVET DJ.

Vista d'insieme

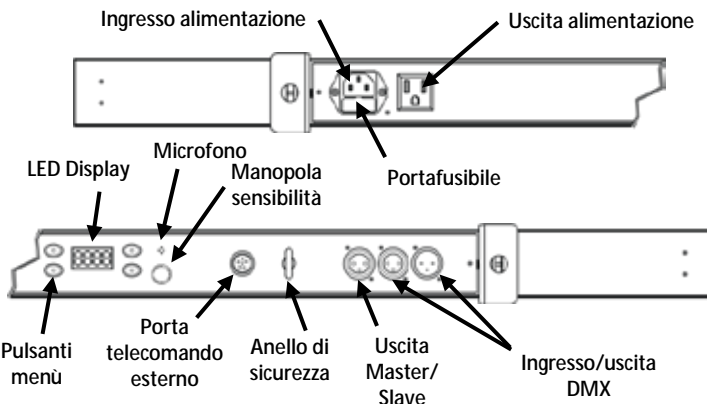

Alimentazione CA

Questa unità è dotata di alimentatore a commutazione automatica con tensione in ingresso di 100–240 V CA, 50/60 Hz.



Per evitarne l'eccessiva usura e migliorarne la durata nel tempo, scollegare l'unità dalla presa elettrica o disattivare l'alimentazione tramite l'apposito interruttore, se inutilizzata per lunghi periodi.

Collegamento

Per il numero massimo di apparecchiature che è possibile collegare su ciascuna presa elettrica fare riferimento alle note riportate sull'etichetta apposta sul prodotto o al Manuale Utente.

Sostituzione fusibile

1. Scollegare l'alimentazione elettrica dall'unità.
2. Inserire la punta di un giravite a testa piatta nella fessura dell'alloggiamento del fusibile.
3. Rimuovere dall'alloggiamento il cappellotto di sicurezza.
4. Rimuovere il fusibile bruciato dalla clip sulla parte anteriore del cappellotto di sicurezza e sostituirlo con uno identico.
5. Reinserire il portafusibile e ricollegare l'alimentazione elettrica.



Dopo aver collegato il prodotto, attendere fino a 30 secondi per l'avvio.

Montaggio Prima di montare l'unità, leggere le [Note di Sicurezza](#).

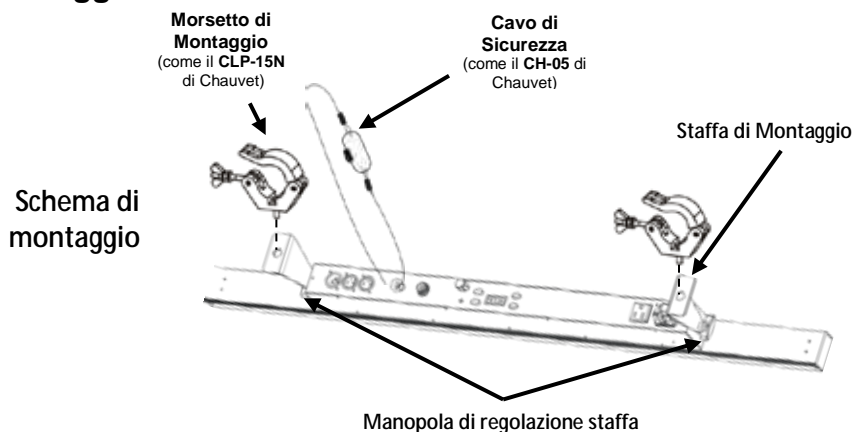

Descrizione del pannello di controllo	Pulsante	Funzione
	<MODE>	Consente di uscire dal menù o dalla funzione corrente
	<ENTER>	Consente di attivare un'opzione di menù o un valore selezionato
	<UP>	Consente di spostarsi verso l'alto nell'elenco menù o di aumentare il valore numerico all'interno di una funzione
	<DOWN>	Consente di spostarsi verso il basso nell'elenco menù o di diminuire il valore numerico all'interno di una funzione

- Collegamento DMX** COLORstrip/COLORstrip Mini può funzionare con un controller DMX quando collegato tramite connessioni seriali DMX. Le istruzioni per il collegamento e la configurazione di questa unità sono contenute nel Manuale Utente. Se non si ha familiarità con il DMX, scaricare DMX Primer all'indirizzo www.chauvetlighting.com.
- Indirizzo iniziale** Per assicurare il completo accesso a tutti i canali in ciascuna modalità DMX, l'indirizzo maggiormente raccomandato è **509**.
Dopo aver impostato l'indirizzo DMX, premere <MODE> seguito da <ENTER> per salvarlo nella memoria dell'unità.
- Collegamento Master/Slave** In modalità Master/Slave, COLORstrip/COLORstrip Mini utilizza il collegamento dati DMX. Le istruzioni per il collegamento e la configurazione di questa unità per il funzionamento Master/Slave sono contenute nel Manuale Utente.
- Modalità Movimento (Runway) Master/Slave** Per la modalità Movimento, COLORstrip/COLORstrip Mini utilizza l'uscita Master/Slave. Le istruzioni per il collegamento e la configurazione di questa unità in modalità Movimento sono contenute nel Manuale Utente.

Opzioni del menu

Livello Principale	Livelli di programmazione				Descrizione
ACT	A000				Blackout
	A001	F000–F100			Rosso (strobo)
	A002	F000–F100			Verde (strobo)
	A003	F000–F100			Blu (strobo)
	A004	F000–F100			Giallo (strobo)
	A005	F000–F100			Viola (strobo)
	A006	F000–F100			Ciano (strobo)
	A007	F000–F100			Bianco (strobo)
	A008	P000–P100	F000–F100		Chase colore 1 (velocità, strobo)
	A009	P000–P100	F000–F100		Chase colore 2 (velocità, strobo)
	A010	P000–P100	F000–F100		Chase colore 3 (velocità, strobo)
	A011	P000–P100	F000–F100		Chase colore 4 (velocità, strobo)
	A012	P000–P100			Chase colore 5 (velocità)
	A013	P000–P100			Chase colore 6 (velocità)
	A014	P000–P100			Chase colore 7 (velocità)
	A015	P000–P100			Chase colore 8 (velocità)
	A016	P000–P100			Chase colore 9 (velocità)
	A017	P000–P100			Chase colore 10 (velocità)
	A018	P000–P100			Chase colore 11 (velocità)
	A019	P000–P100			Chase colore 12 (velocità)
	A020	P000–P100			Chase colore 13 (velocità)
	A021	r000–r100	G000–G100	b000–b100	F000–F100
A022	P000–P100			Fade dei colori (velocità)	
A023					Chase per tutti i colori 1–13 (velocità)
SYS	SdAd		001– 509		Indirizzo DMX
	SAAd				Reimpostazione



Per salvare la modalità corrente nella memoria dell'unità premere <MODE> seguito da <ENTER>. La modalità salvata si attiverà all'avvio.

Telecomando IRC-6 (a infrarossi)

COLORstrip/COLORstrip Mini è compatibile con il telecomando IRC-6 di Chauvet.

Con COLORstrip/COLORstrip Mini vengono utilizzati i seguenti pulsanti del telecomando:



Attiva/disattiva i LED

Aumenta la velocità (del programma strobo) o il valore del colore

Diminuisce la velocità (del programma strobo) o il valore del colore

Abilita l'impostazione strobo

Abilita il mixaggio colore

Imposta il valore del colore Rosso

Imposta il valore del colore Verde

Imposta il valore del colore Blu

Attiva o disattiva la modalità Auto/Sonora

Attiva o disattiva la modalità Auto/Sonora

NOTA - Se la modalità Auto/Sonora non è attiva, è attiva la modalità Colore statico.

Modalità Colore statico	Modalità automatica / attivazione sonora
0 A007 (Bianco)	0 A008
1 A001 (Rosso)	1 A009
2 A021 (Ambra)	2 A010
3 A004 (Giallo)	3 A011
4 A002 (Verde)	4 A012
5 A006 (Ciano)	5 A013
6 A003 (Blu)	6 A014
7 A005 (Viola)	7 A015
8 A021 (Rosa)	8 A017
9 A021 (Girasole)	9 A023
FADE Nessuna funzione	FADE A022 (Nessuna risposta al suono)



- Nessuna funzione con questo prodotto
- L'impostazione predefinita per la modalità Colore statico è **A007** (Bianco).
- L'impostazione predefinita per la modalità Auto/Sonora è **A008**.

Valori DMX

4 Canali	Canale	Funzione	Valore	Percentuale/Impostazione
1	1	Colori statici	000 ó 009	Nessuna funzione
			010 ó 019	Rosso 0–100%
			020 ó 029	Verde 0–100%
			030 ó 039	Blu 0–100%
			040 ó 049	Giallo 0–100%
			050 ó 059	Magenta 0–100%
			060 ó 069	Ciano 0–100%
			070 ó 079	Bianco 0–100%
		Chase Colori	080 ó 089	Chase Colori 1
			090 ó 099	Chase Colori 2
			100 ó 109	Chase Colori 3
			110 ó 119	Chase Colori 4
			120 ó 129	Chase Colori 5
	130 ó 139		Chase Colori 6	
	140 ó 149		Chase Colori 7	
	150 ó 159		Chase Colori 8	
	160 ó 169		Chase Colori 9	
	170 ó 179		Chase Colori 10	
	180 ó 189		Chase Colori 11	
	190 ó 199		Chase Colori 12	
200 ó 209	Chase Colori 13			
	Mixaggio colore RGB	210 ó 219	Canali 2–4	
	Fade dei colori	220 ó 229	Fade dei colori	
	Attivazione sonora	230 ó 255	Attivazione sonora	
2	Velocità di esecuzione (quando il can. 1 è tra 080–209)	000 ó 127	Lento-veloce	
		128 ó 255	Attivazione sonora (lento-veloce)	
	Rosso (quando il can. 1 è tra 210–219)	000 ó 255	0–100%	
		Velocità Fade (quando il can. 1 è tra 220–229)	000 ó 255	Lento-veloce
3	Strobo (quando il can. 1 è tra 010–119)	000 ó 249	Lento-veloce	
		250 ó 255	Attivazione sonora	
	Verde (quando il can. 1 è tra 210–219)	000 ó 255	0–100%	
4	Blu (quando il can. 1 è tra 210–219)	000 ó 255	0–100%	

Over deze handleiding

De COLORstrip/COLORstrip Mini Beknopte Handleiding (BH) bevat basisinformatie over het product, zoals montage, menu-opties en DMX-waarden. Download de gebruikershandleiding op www.chauvetlighting.com voor meer informatie.

Disclaimer

De informatie en specificaties in deze BH kunnen zonder voorafgaande kennisgeving worden gewijzigd.

Veiligheidsinstructies

Deze veiligheidsinstructies bevatten belangrijke informatie over de installatie, het gebruik en het onderhoud.



- Dit product is niet bedoeld voor permanente installatie.
- Sluit dit product UITSLUITEND op een geaard en beveiligd stroomcircuit.
- Haal voor het vervangen van de zekering altijd de stekker van het product uit het stopcontact.
- KIJK NIET in de lichtbron wanneer het apparaat is ingeschakeld.
- Zorg ervoor dat het stroomsnoer niet knikt of beschadigd.
- Koppel dit product nooit los van het stopcontact door aan het snoer te trekken.
- Gebruik een veiligheidskabel wanneer het product boven lichaamshoogte wordt gemonteerd.
- GEEN brandbare materialen in de buurt van de unit tijdens gebruik.
- RAAK het product NIET AAN wanneer het in werking omdat het dan heet zijn.



- De spanning van het stopcontact waarop u dit product aansluit moet binnen het vermelde bereik op de sticker of achterkant van het product zijn.
- Het product is alleen voor gebruik binnenshuis! (IP20) Om risico op brand of elektrische schokken te voorkomen, mag dit product niet aan regen of vocht worden blootgesteld.
- Monteer dit product altijd op een plek met voldoende ventilatie, minstens 20 inch (50 cm) van de aangrenzende oppervlakken.
- Zorg ervoor dat er geen ventilatie-openingen van de behuizing van het product worden geblokkeerd.
- Sluit dit product nooit aan op een dimmer of een regelweerstand.
- Vervang de zekering met een van hetzelfde type en met dezelfde waarde.
- Gebruik UITSLUITEND de ophang-/montagebeugel of de hendels om dit product te dragen.
- De maximale omgevingstemperatuur bedraagt 40 °C. Gebruik dit product niet bij hogere temperaturen.
- Stop in het geval van ernstige operationele problemen onmiddellijk met het gebruik.
- Open het product NIET. Het bevat geen te onderhouden onderdelen.
- Om onnodige slijtage te elimineren en zijn levensduur te verlengen, gedurende perioden wanneer het product niet wordt gebruikt, moet u het product afsluiten door een aardlekschakelaar om te zetten of door het te ontkoppelen.

Contact

Van buiten de VS, Verenigd Koninkrijk, Ierland, Mexico of Benelux kunt u contact opnemen met de distributeur of om ondersteuning vragen dan wel het product retourneren. Ga naar www.chauvetlighting.com voor contactinformatie.

Wat is inbegrepen

- COLORstrip
- of
- COLORstrip Mini
- Stroomsnoer
- L-Haken met bevestigingsapparatuur
- Garantiekaart
- Beknopte handleiding

Om te beginnen

Product-beschrijving

Pak uw COLORstrip/COLORstrip Mini uit en zorg ervoor dat u alle onderdelen in goede staat hebt ontvangen. Als de doos of inhoud beschadigd lijkt, stel dan de vervoerder onmiddellijk op de hoogte, niet Chauvet.

De COLORstrip/COLORstrip Mini is een compacte, meerkleurige strooklamp voor gebruik in mobiele amusements toepassingen binnenshuis. De COLORstrip/COLORstrip Mini is perfect als een washlamp of effectlamp wanneer deze wordt gekoppeld met andere COLORstrip-producten. Ingebouwde infrarood technologie biedt draadloze bediening met de optionele infrarood afstandsbediening (IRC-6) van CHAUVET DJ.

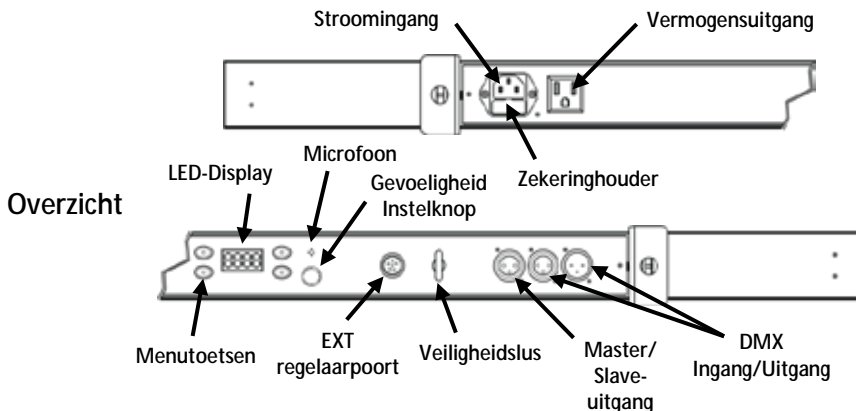

AC-stroom

Dit product heeft een voeding met automatisch bereik die werkt met een ingangsspanning van 100–240 VAC, 50/60 Hz.



Om onnodige slijtage te elimineren en zijn levensduur te verlengen, gedurende perioden wanneer het product niet wordt gebruikt, moet u het product afsluiten door een aardlekschakelaar om te zetten of door het te ontkoppelen.

Power Linking

Voor het maximale aantal COLORstrip/COLORstrip Mini-producten die via power link kunnen worden gekoppeld bij elke spanning, ziet u de gebruikershandleiding of de sticker op het product.

Vervangen van de zekering

1. Ontkoppel het apparaat van de stroom.
2. Wig de punt van een platte schroevendraaier in de sleuf van de zekeringhouder.
3. Druk de beveiligingskap uit de behuizing.
4. Verwijder de doorgebrande zekering vanaf de clip aan de voorkant van de veiligheidsafdekking en vervang deze door een zekering van exact hetzelfde type.
5. Plaats de zekeringhouder terug en steek de stekker er weer in.



Bij het aansluiten van het product, geef het tot 30 seconden de tijd om op te starten.

Montage Lees alvorens dit product te monteren alle [Veiligheidsinstructies](#).

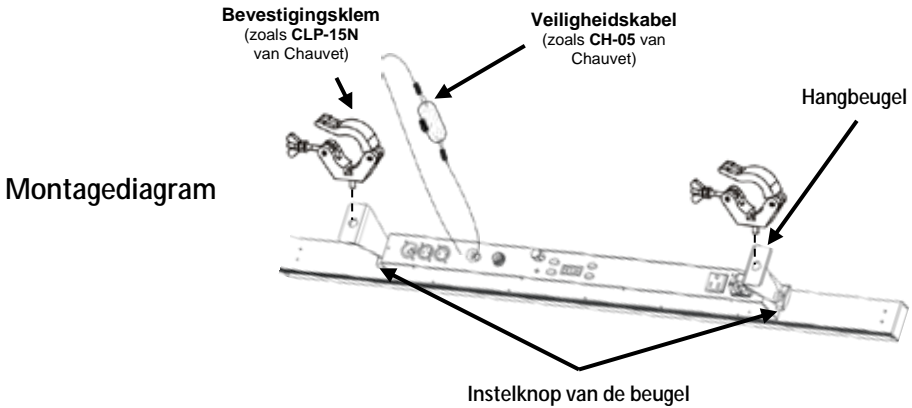

Configuratie- scherm Beschrijving	Toets	Functie
	<MODE>	Sluit het huidige menu of functie af
	<ENTER>	Activeert een menu-optie of de geselecteerde waarde
	<UP>	Navigeert omhoog via het menu of verhoogt de numerieke waarde wanneer in een functie
	<DOWN>	Navigeert omlaag via het menu of verlaagt de numerieke waarde wanneer in een functie

- DMX-koppeling** De COLORstrip/COLORstrip Mini kan met een DMX-regelaar werken, indien gekoppeld door seriële DMX-verbindingen. Instructies voor het aansluiten en configureren van dit product voor DMX-bediening staan in de gebruikershandleiding. Als u niet bekend bent met DMX, download dan de DMX-primer op www.chauvetlighting.com.
- Startadres** Om volledige toegang tot alle kanalen in elke DMX-modus te garanderen is het sterk aanbevolen DMX-adres voor dit product **509**. Na het instellen van het startende DMX adres, drukt u op **<MODE>** en **<ENTER>** om het adres op het geheugen van het product op te slaan.
- Master/slave-verbinding** De COLORstrip/COLORstrip Mini maakt gebruik van de DMX-gegevensverbinding voor haar Master-/Slave-modus. Instructies voor het aansluiten en configureren van dit product voor DMX-bediening staan in de gebruikershandleiding.
- Master/Slave landingsbaan-modus** De COLORstrip/COLORstrip Mini gebruikt de Master/Slave-uitgang voor zijn landingsbaan-modus. Instructies voor het aansluiten en configureren van dit product voor landingsbaan-modus bediening staan in de gebruikershandleiding.

Menu Opties

Hoofd-functie	Programmeerniveaus				Beschrijving	
AAct	A000				Verduistering	
	A001		F000–F100		Rood (stroboscoop)	
	A002		F000–F100		Groen (stroboscoop)	
	A003		F000–F100		Blauw (stroboscoop)	
	A004		F000–F100		Geel (stroboscoop)	
	A005		F000–F100		Paars (stroboscoop)	
	A006		F000–F100		Cyaan (stroboscoop)	
	A007		F000–F100		Wit (stroboscoop)	
	A008		P000–P100	F000–F100		Kleurenachtervolgving 1 (snelheid, stroboscoop)
	A009		P000–P100	F000–F100		Kleurenachtervolgving 2 (snelheid, stroboscoop)
	A010		P000–P100	F000–F100		Kleurenachtervolgving 3 (snelheid, stroboscoop)
	A011		P000–P100	F000–F100		Kleurenachtervolgving 4 (snelheid, stroboscoop)
	A012		P000–P100		Kleurenachtervolgving 5 (snelheid)	
	A013		P000–P100		Kleurenachtervolgving 6 (snelheid)	
	A014		P000–P100		Kleurenachtervolgving 7 (snelheid)	
	A015		P000–P100		Kleurenachtervolgving 8 (snelheid)	
	A016		P000–P100		Kleurenachtervolgving 9 (snelheid)	
	A017		P000–P100		Kleurenachtervolgving 10 (snelheid)	
	A018		P000–P100		Kleurenachtervolgving 11 (snelheid)	
	A019		P000–P100		Kleurenachtervolgving 12 (snelheid)	
	A020		P000–P100		Kleurenachtervolgving 13 (snelheid)	
	A021	r000–r100	G000–G100	b000–b100	F000–F100	Kleurenmix (rood, groen, blauw, stroboscoop)
A022		P000–P100		Kleurenfade (snelheid)		
A023				Alle kleurachtervolgingen 1–13 (snelheid)		
SYS	SdAd		001– 509		DMX-adres	
	SAAd				Reset	



































Om de huidige op te slaan op het geheugen van het product, drukt u op <MODE> en <ENTER>. De opgeslagen modus zal geactiveerd worden bij het opstarten.







IRC-6-Afstandsbediening (Infrarood Afstandsbediening)

De COLORstrip/COLORstrip Mini is compatibel met de IRC-6 afstandsbediening van Chauvet.

De volgende IRC-6 toetsen worden gebruikt met de COLORstrip/COLORstrip Mini:

-  Schakelt LED-lampjes aan/uit
 -  Verhoogt de snelheid (van programma of stroboscoop) of kleurwaarde
 -  Verlaagt de snelheid (van programma of stroboscoop) of kleurwaarde
 -  Schakelt de stroboscoopinstelling in
 -  Schakelt kleurenmenging in
 -  Stelt de rode kleurwaarde in
 -  Stelt de groene kleurwaarde in
 -  Stelt de blauwe kleurwaarde in
 -  Schakelt automatische/geluidsmodus in, of schakelt automatische/geluidsmodus uit
 -  Schakelt automatische/geluidsmodus in, of schakelt automatische/geluidsmodus uit
- LET OP** - Als de automatische/geluidsmodus uit is, is de statische kleurenmodus aan.

Statisch-Kleurenmodus		Automatische/geluidsmodus	
 0	A007 (Wit)	 0	A008
 1	A001 (Rood)	 1	A009
 2	A021 (Amber)	 2	A010
 3	A004 (Geel)	 3	A011
 4	A002 (Groen)	 4	A012
 5	A006 (Cyaan)	 5	A013
 6	A003 (Blauw)	 6	A014
 7	A005 (Paars)	 7	A015
 8	A021 (Roze)	 8	A017
 9	A021 (Zonnebloem)	 9	A023
 FADE	Geen functie	 FADE	A022 (Geen reactie op geluid)

-        - Geen functie met dit product
- De standaard voor statische kleurenmodus is A007 (wit).
- De standaard voor automatische/geluidsmodus is A008.

DMX-waarden

4 Kanalen	Kanaal	Functie	Waarde	Percentage/instelling
1	Statischkleuren		000 ó 009	Geen functie
			010 ó 019	Rood 0–100%
			020 ó 029	Groen 0–100%
			030 ó 039	Blaauw 0–100%
			040 ó 049	Geel 0–100%
			050 ó 059	Magenta 0–100%
			060 ó 069	Cyaan 0–100%
			070 ó 079	Wit 0–100%
	Kleurachtervolgingen		080 ó 089	Kleurenachtervolging 1
			090 ó 099	Kleurenachtervolging 2
			100 ó 109	Kleurenachtervolging 3
			110 ó 119	Kleurenachtervolging 4
			120 ó 129	Kleurenachtervolging 5
			130 ó 139	Kleurenachtervolging 6
			140 ó 149	Kleurenachtervolging 7
			150 ó 159	Kleurenachtervolging 8
			160 ó 169	Kleurenachtervolging 9
			170 ó 179	Kleurenachtervolging 10
			180 ó 189	Kleurenachtervolging 11
			190 ó 199	Kleurenachtervolging 12
		200 ó 209	Kleurenachtervolging 13	
		RGB-kleurenmenging	210 ó 219	Kanalen 2–4
		Kleurenfade	220 ó 229	Kleurenfade
	Geluidsactief	230 ó 255	Geluidsactief	
2	Loopsnelheid (wanneer K. 1 is 080–209)		000 ó 127	Langzaam tot snel
			128 ó 255	Geluidsactief (en langzaam tot snel)
	Rood (wanneer K. 1 is 210–219)		000 ó 255	0–100%
		Fadesnelheid (wanneer K. 1 is 220–229)		000 ó 255
3	Stroboscoop (wanneer K. 1 is 010–119)		000 ó 249	Langzaam tot snel
			250 ó 255	Geluidsactief
	Groen (wanneer K. 1 is 210–219)		000 ó 255	0–100%
4	Blaauw (wanneer K. 1 is 210–219)		000 ó 255	0–100%

Contact USA WORLD HEADQUARTERS**Us****General Information**

Address: 5200 NW 108th Avenue
 Sunrise, FL 33351
 Voice: (954) 577-4455
 Fax: (954) 929-5560
 Toll free:(800) 762-1084

Technical Support

Voice: (954) 577-4455 (Press 4)
 Fax: (954) 756-8015
 Email: tech@chauvetlighting.com

World Wide Web

www.chauvetlighting.com

EUROPE.**General Information**

Address: Stokstraat 18
 9770 Kruishoutem
 Belgium
 Voice: +32 9 388 93 97

General Information

Address: Unit 1C
 Brookhill Road Industrial Estate
 Pinxton, Nottingham, UK
 NG16 6NT
 Voice: +44 (0)1773 511115
 Fax: +44 (0)1773 511110

Technical Support

Email: Eutech@chauvetlighting.eu

World Wide Web

www.chauvetlighting.eu

Technical Support

Email: uktech@chauvetlighting.com

World Wide Web

www.chauvetlighting.co.uk

MEXICO**General Information**

Address: Av. Santa Ana 30
 Parque Industrial Lerma
 Lerma, Mexico C.P. 52000
 Voice: +52 (728) 285-5000

Technical Support

Email: servicio@chauvet.com.mx

World Wide Web

www.chauvet.com.mx

Outside the U.S., United Kingdom, Ireland, Mexico, or Benelux, contact the dealer of record. Follow their instructions to request support or to return a product. Visit our website for contact details.

COLORstrip/COLORstrip Mini QRG Rev. 2 ML6

© Copyright 2016 Chauvet

All rights reserved.

Printed in the P. R. C.

