

COLO*Rstrip*TM

User Manual

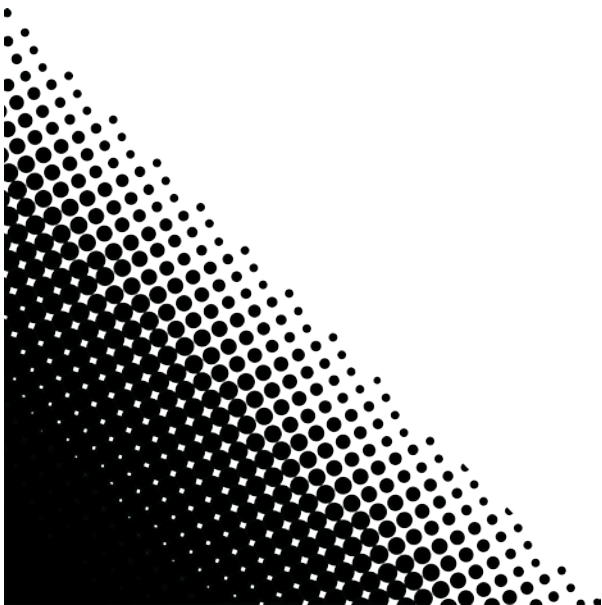
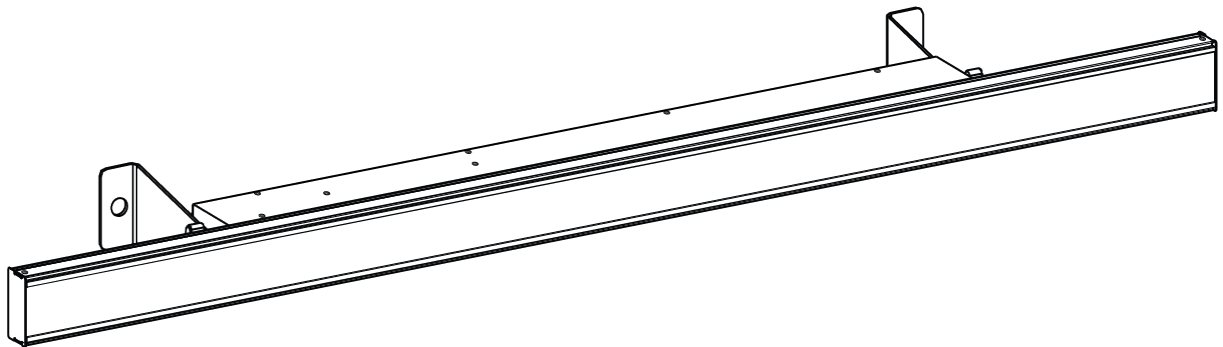

TABLE OF CONTENTS

1. Before You Begin	3
What Is Included	3
Unpacking Instructions	3
Claims.....	3
Text Conventions	3
Symbols	3
Disclaimer	3
Product at a Glance	4
Safety Notes.....	4
2. Introduction	5
Product Overview	5
Product Dimensions	6
3. Setup	7
AC Power	7
Fuse Replacement	7
Power Linking	7
Mounting	8
Orientation	8
Rigging	8
4. Operation	9
Control Panel Operation.....	9
Menu Map	9
DMX Linking.....	9
Configuration (DMX)	9
Starting Address	9
DMX Channel Assignments and Values	10
4-CH	10
Configuration (Standalone)	11
Static Color	11
Automatic and Sound-Active Mode.....	11
Custom Color.....	12
Blackout.....	12
Reset	12
IRC-6 Infrared Remote Control	13
IRC-6 Operation.....	13
Master/Slave Mode	14
Master/Slave Runway Effect.....	14
5. Maintenance	15
Product Maintenance	15
6. Technical Specifications	16
Returns	17
Contact Us	18

1. BEFORE YOU BEGIN

What Is Included

- COLORstrip™
- Power Cord
- Hanging Brackets with Mounting Hardware (L-Brackets)
- Warranty Card
- Quick Reference Guide

Unpacking Instructions

Carefully unpack the product immediately and check the container to make sure all the parts are in the package and are in good condition.

Claims





If the box or the contents (the product and included accessories) appear damaged from shipping, or show signs of mishandling, notify the carrier immediately, not Chauvet. Failure to report damage to the carrier immediately may invalidate your claim. In addition, keep the box and contents for inspection.

For other issues, such as missing components or parts, damage not related to shipping, or concealed damage, file a claim with Chauvet within 7 days of delivery.

Text Conventions

Convention	Meaning
1—512	A range of values
50/60	A set of values of which only one can be chosen
Settings	A menu option not to be modified
Menu > Settings	A sequence of menu options to be followed
<ENTER>	A key to be pressed on the product's control panel
ON	A value to be entered or selected

Symbols

Symbol	Meaning
	Electrical warning. Not following these instructions may cause electrical damage to the product, accessories, or the user.
	Critical installation, configuration, or operation information. Not following these instructions may make the product not work, cause damage to the product, or cause harm to the operator.
	Important installation or configuration information. The product may not function correctly if this information is not used.
	Useful information.

Disclaimer

The information and specifications contained in this document are subject to change without notice. Chauvet assumes no responsibility or liability for any errors or omissions that may appear in this manual. Chauvet reserves the right to update the existing document or to create a new document to correct any errors or omissions.

You can download the latest version of this document from www.chauvetlighting.com.

© Copyright 2015 Chauvet. All rights reserved.

Electronically published by Chauvet in the United States of America.

Author	Date	Editor	Updated
R. Isenstadt	06/22/15	A. Leon	06/29/15

Product at a Glance

Use on Dimmer	X	Auto Programs	P
Outdoor Use	X	Auto-ranging Power Supply	P
Sound-Active	P	Replaceable Fuse	P
DMX	P	User-Serviceable	X
Master/Slave	P		

Safety Notes

Please read the following Safety Notes carefully before working with the product. The Notes include important safety information about installation, usage, and maintenance.



- Always connect the product to a grounded circuit to avoid the risk of electrocution.
- Always disconnect the product from the power source before cleaning or replacing the fuse.
- Avoid direct eye exposure to the light source while the product is on.
- Make sure the power cord is not crimped or damaged.
- Never disconnect the product from power cord by pulling or tugging on the cord.
- If mounting the product overhead, always secure to a fastening device using a safety cable.
- Make sure there are no flammable materials close to the product when operating.
- Do not touch the product's housing when operating because it may be very hot.



- The product is not intended for permanent installation.
- Always make sure that the voltage of the outlet to which you are connecting the product is within the range stated on the decal or rear panel of the product.
- The product is for indoor use only! (IP20) To prevent risk of fire or shock, do not expose the product to rain or moisture.
- Always install the product in a location with adequate ventilation, at least 20 in (50 cm) from adjacent surfaces.
- Be sure that no ventilation slots on the product's housing are blocked.
- Never connect the product to a dimmer.
- Make sure to replace the fuse with another of the same type and rating.
- Never carry the product from the power cord or any moving part. Always use the hanging/mounting bracket.
- The maximum ambient temperature (Ta) is 104 °F (40 °C). Do not operate the product at higher temperatures.
- In the event of a serious operating problem, stop using the product immediately.
- Never try to repair the product. Repairs carried out by unskilled people can lead to damage or malfunction. Please contact the nearest authorized technical assistance center.
- To eliminate unnecessary wear and improve its lifespan, during periods of non-use completely disconnect the product from power via breaker or by unplugging it.



Keep this User Manual for future use. If you sell the product to someone else, be sure that they also receive this document.

2. INTRODUCTION

Product Overview

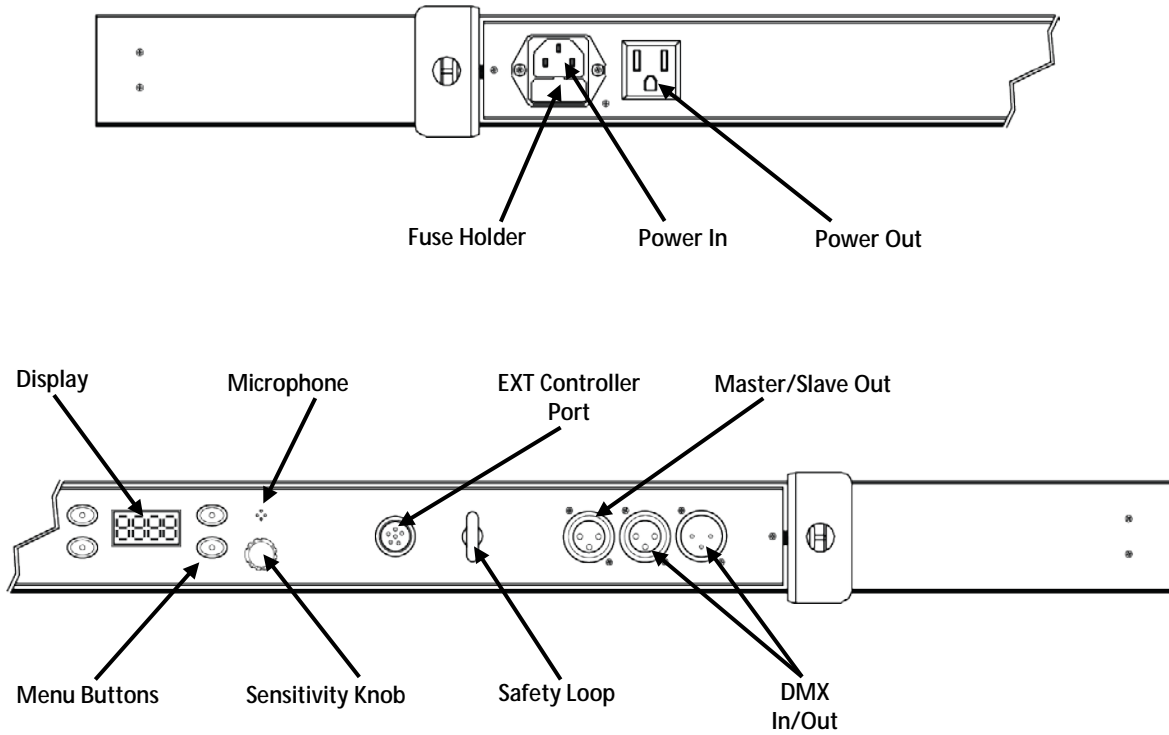

Product Dimensions

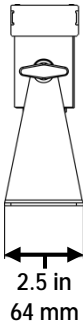
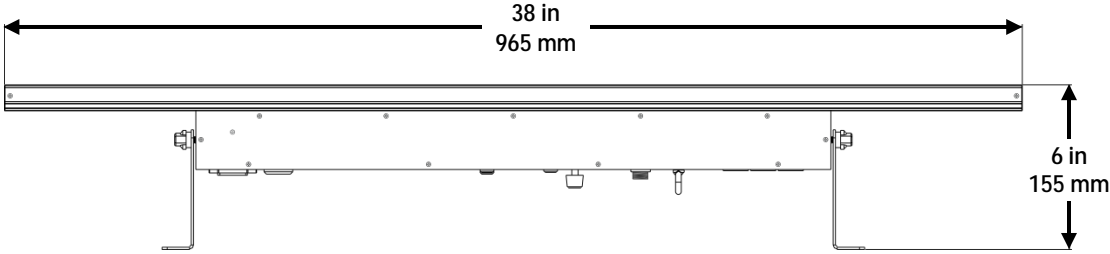

3. SETUP

AC Power

The COLORstrip™ has an auto-ranging power supply and it can work with an input voltage range of 100 to 240 VAC, 50/60 Hz. To determine the product's power requirements (circuit breaker, power outlet, and wiring), use the current value listed on the label affixed to the product's back panel, or refer to the product's specifications chart. The listed current rating indicates the product's average current draw under normal conditions.

- **Always connect the product to a protected circuit (circuit breaker or fuse). Make sure the product has an appropriate electrical ground to avoid the risk of electrocution or fire.**
- **To eliminate unnecessary wear and improve its lifespan, during periods of non-use completely disconnect the product from power via breaker or by unplugging it.**



Fuse Replacement

Never connect the product to a rheostat (variable resistor) or dimmer circuit, even if the rheostat or dimmer channel serves only as a 0 to 100% switch.

1. Wedge the tip of a flat-head screwdriver into the slot of the fuse holder.
2. Pry the fuse holder out of the housing.
3. Remove the blown fuse from the holder and replace with a fuse of the exact same type and rating.
4. Insert the fuse holder back in place and reconnect power.

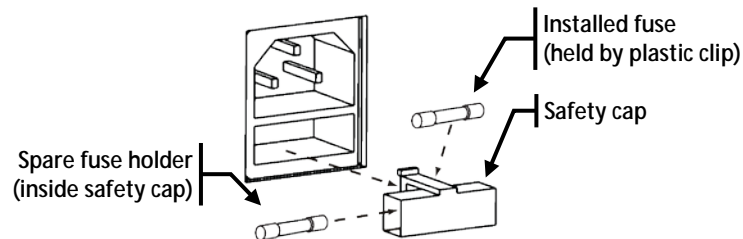

Disconnect the product from the power outlet before replacing the fuse.

Power Linking

The product provides power linking via the Edison outlet located in the back of the product. Please see the diagram below for further explanation.

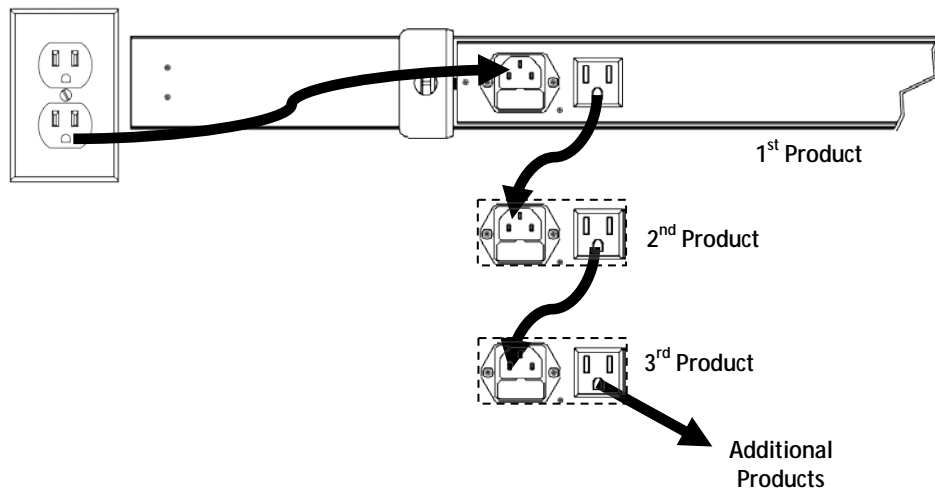

Power Linking Diagram



You can power link up to 15 COLORstrip™ products on 120 VAC or up to 28 COLORstrip™ products on 230 VAC.



The power linking diagram corresponds to the North American version of the product ONLY! If using the product in other markets, you must consult with the local Chauvet distributor as power linking connectors and requirements may differ in your country or region.

Mounting Before mounting the product, read and follow the safety recommendations indicated in the [Safety Notes](#).

Orientation The COLORstrip™ may be mounted in any position; however, make sure adequate ventilation is provided around the product.

- Rigging**
- Before deciding on a location for the product, always make sure there is easy access to the product for maintenance and programming purposes.
 - Make sure that the structure onto which you are mounting the product can support the product's weight. See the [Technical Specifications](#) for weight information.
 - When mounting the product overhead, always use a safety cable. Mount the product securely to a rigging point, whether an elevated platform or a truss.
 - When rigging the product onto a truss, use a mounting clamp of appropriate weight capacity.
 - When power linking multiple products, mount the products close enough for power linking cables to reach.
 - The bracket adjustment knobs allow for directional adjustment when aiming the product to the desired angle. Only loosen or tighten the bracket knobs manually. Using tools could damage the knobs.

Mounting Diagram

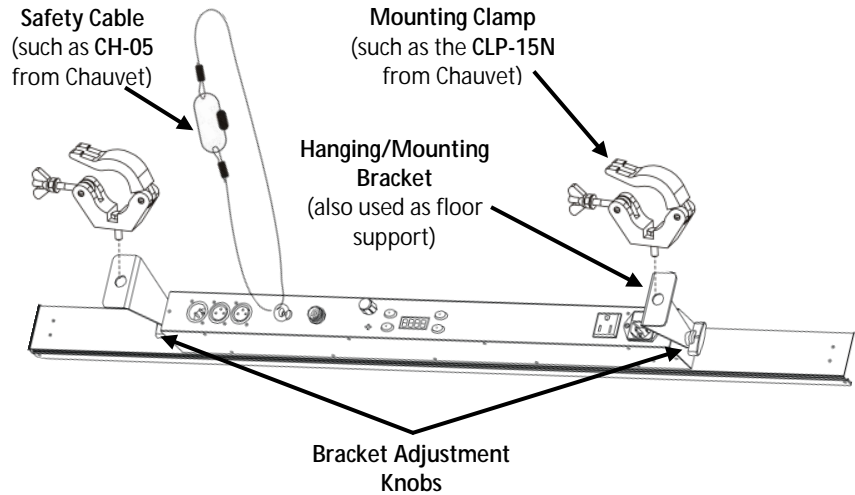

4. OPERATION

Control Panel Operation

To access the control panel functions, use the four buttons located underneath the display. Please refer to the [Product Overview](#) to see the button locations on the control panel.

Button	Function
<MODE>	Press to back out of the current menu option
<ENTER>	Press to activate a menu option or a selected value
<UP>	Press to scroll up the list of options or to find a higher value
<DOWN>	Press to scroll down the list of options or to find a lower value

Menu Map

Mode	Programming Steps				Description		
ACT	A000				Blackout		
	A001		F000–F100		Red (strobe)		
	A002		F000–F100		Green (strobe)		
	A003		F000–F100		Blue (strobe)		
	A004		F000–F100		Yellow (strobe)		
	A005		F000–F100		Purple (strobe)		
	A006		F000–F100		Cyan (strobe)		
	A007		F000–F100		White (strobe)		
	A008		P000–P100	F000–F100		Color Chase 1 (speed, strobe)	
	A009		P000–P100	F000–F100		Color Chase 2 (speed, strobe)	
	A010		P000–P100	F000–F100		Color Chase 3 (speed, strobe)	
	A011		P000–P100	F000–F100		Color Chase 4 (speed, strobe)	
	A012		P000–P100			Color Chase 5 (speed)	
	A013		P000–P100			Color Chase 6 (speed)	
	A014		P000–P100			Color Chase 7 (speed)	
	A015		P000–P100			Color Chase 8 (speed)	
	A016		P000–P100			Color Chase 9 (speed)	
	A017		P000–P100			Color Chase 10 (speed)	
	A018		P000–P100			Color Chase 11 (speed)	
	A019		P000–P100			Color Chase 12 (speed)	
	A020		P000–P100			Color Chase 13 (speed)	
	A021		r000–r100	G000–G100	b000–b100	F000–F100	Color Mix (red, green, blue, strobe)
	A022		P000–P100			Color fade (speed)	
A023					All Color Chases 1–13 (speed)		
SYS	SdAd		001– 509		DMX Address		
	AAAd				Reset		

DMX Linking

The COLORstrip™ works with a DMX controller. Information about DMX is in the CHAUVET® DMX Primer, which is available from the Chauvet website http://www.chauvetlighting.com/downloads/DMX_Primer_rev05_WO.pdf.

Configuration (DMX)

Set the product in DMX mode to control with a DMX controller.

1. Connect the product to a suitable power outlet.
2. Connect a DMX cable from the DMX output of the DMX controller to the DMX input socket on the product.

Starting Address

When selecting a starting DMX address, always consider the number of DMX channels the selected DMX mode uses. If you choose a starting address that is too high, you could restrict the access to some of the product's channels.

The COLORstrip™ uses 4 DMX channels, and the highest configurable address is **509**.

If you are not familiar with the DMX protocol, download the DMX Primer from www.chauvetlighting.com.

To select the starting address, do the following:

1. Press <MODE> repeatedly until **SYS** or **ACT** shows on the display.
2. Press <UP> or <DOWN> repeatedly until **SYS** shows on the display.
3. Press <ENTER>.
4. Press <UP> or <DOWN> repeatedly until **SdAd** show on the display.
5. Press <ENTER> and **001– 508** will show on the display.
6. Use <UP> or <DOWN> to select the starting address.
7. Press <ENTER>.

DMX Channel Assignments and Values

4-CH	Channel	Function	Value	Percent/Setting
1	Static Colors		000 ó 009	No function
			010 ó 119	Red 0–100%
			020 ó 029	Green 0–100%
			030 ó 039	Blue 0–100%
			040 ó 049	Yellow 0–100%
			050 ó 059	Magenta 0–100%
			060 ó 069	Cyan 0–100%
			070 ó 079	White 0–100%
	Color Chases		080 ó 089	Color Chase 1
			090 ó 099	Color Chase 2
			100 ó 109	Color Chase 3
			110 ó 119	Color Chase 4
			120 ó 129	Color Chase 5
			130 ó 139	Color Chase 6
			140 ó 149	Color Chase 7
			150 ó 159	Color Chase 8
			160 ó 169	Color Chase 9
			170 ó 179	Color Chase 10
			180 ó 189	Color Chase 11
			190 ó 199	Color Chase 12
		200 ó 209	Color Chase 13	
		RGB Color Mixing	210 ó 219	Channels 2–4
		Color Fade	220 ó 229	Color Fade
	Sound-Active	230 ó 255	Sound-Active	
2	Run Speed (when Ch. 1 is 080–209)	000 ó 127	Slow to fast	
		128 ó 255	Sound-Active	
	Red (when Ch. 1 is 210–219)	000 ó 255	0–100%	
	Fade Speed (when Ch. 1 is 220–229)	000 ó 255	Slow to fast	
3	Strobe (when Ch. 1 is 010–119)	000 ó 127	Slow to fast	
		250 ó 255	Sound-Active	
	Green (when Ch. 1 is 210–219)	000 ó 255	0–100%	
4	Blue (when Ch. 1 is 210–119)	000 ó 255	0–100%	

Configuration (Standalone)

Set the product in one of the standalone modes to control without a DMX controller.
Connect the product to a suitable power outlet.



Never connect a product that is operating in any standalone mode to a DMX string connected to a DMX controller. Products in standalone mode may transmit DMX signals that could interfere with the DMX signals from the controller.

Static Color

To run the COLORstrip™ on a static color, follow the instructions below:

1. Press **<MODE>** repeatedly until **SYS** or **ACt** shows on the display.
2. Press **<UP>** or **<DOWN>** repeatedly until **ACt** shows on the display.
3. Press **<ENTER>**.
4. Use **<UP>** or **<DOWN>** to scroll through the menu until **A001–A007** shows on the display.
5. Press **<ENTER>** and **Fxxx** will show on the display.
6. Use **<UP>** or **<DOWN>** to increase or decrease the strobe value.
 - Set **F000** for no strobe.
 - Set **F100** for sound-active strobe (Sensitivity knob must be turned up).
 - Set **F001–F099** for auto strobe, from slow to fast.
7. Press **<ENTER>**.

Automatic and Sound-Active Mode

To run a color chase, do the following:

1. Press **<MODE>** repeatedly until **SYS** or **ACt** shows on the display.
2. Press **<UP>** or **<DOWN>** repeatedly until **ACt** shows on the display.
3. Press **<ENTER>**.
4. Use **<UP>** or **<DOWN>** to scroll through the menu until **A008–A020** or **A022–A023** shows on the display.
5. Press **<ENTER>** and **Pxxx** will show on the display.
6. Use **<UP>** or **<DOWN>** to increase or decrease the program speed.
7. Set **P000** for sound-active only (Sensitivity knob must be turned up).
8. Set **P001–P100** for auto mode, from slow to fast.
9. Press **<ENTER>**. For **A008–A011**, **Fxxx** will show on the display.
10. Use **<UP>** or **<DOWN>** to increase or decrease the strobe value.
11. Set **F000** for no strobe.
12. Set **F100** for sound-active strobe (Sensitivity knob must be turned up).
13. Set **F001–F099** for auto strobe, from slow to fast.
14. Press **<ENTER>**.

For Sound-Active mode, turn the Sensitivity knob up until the product responds to the beat of the music.



In Sound-Active modes, the product will only respond to low frequencies of music (bass and drums).

Custom Color

To custom mix a color, follow the instructions below:

1. Press **<MODE>** repeatedly until **SYS** or **ACt** shows on the display.
2. Press **<UP>** or **<DOWN>** repeatedly until **ACt** shows on the display.
3. Press **<ENTER>**.
4. Use **<UP>** or **<DOWN>** to scroll through the menu until **A021** shows on the display.
5. Press **<ENTER>** and **rxxx** will show on the display.
6. Use **<UP>** or **<DOWN>** to increase or decrease the red value.
7. Press **<ENTER>** and **Gxxx** will show on the display.
8. Use **<UP>** or **<DOWN>** to increase or decrease the green value.
9. Press **<ENTER>** and **bxxx** will show on the display.
10. Use **<UP>** or **<DOWN>** to increase or decrease the blue value.
11. Press **<ENTER>** and **Fxxx** will show on the display.
12. Use **<UP>** or **<DOWN>** to increase or decrease the strobe value.
 - Set **F000** for no strobe.
 - Set **F100** for sound-active strobe (Sensitivity knob must be turned up).
 - Set **F001–F099** for auto strobe, from slow to fast.
13. Press **<ENTER>**. Repeat steps 3 – 12 as necessary.

Blackout

To black out the COLORstrip™, do the following:

1. Press **<MODE>** repeatedly until **SYS** or **ACt** shows on the display.
2. Press **<UP>** or **<DOWN>** repeatedly until **ACt** shows on the display.
3. Press **<ENTER>**.
4. Use **<UP>** or **<DOWN>** to scroll through the menu until **A000** shows on the display.
5. Press **<ENTER>**.

Reset

To reset the COLORstrip™, follow the instructions below:

1. Press **<MODE>** repeatedly until **SYS** or **ACt** shows on the display.
2. Press **<UP>** or **<DOWN>** repeatedly until **SYS** shows on the display.
3. Press **<ENTER>**.
4. Press **<UP>** or **<DOWN>** repeatedly until **AAAd** shows on the display.
5. Press **<ENTER>**.

IRC-6 Infrared Remote Control

The COLORstrip™ is compatible with the IRC-6 infrared remote control from Chauvet. Make sure to point the IRC-6 directly at the receiver on the front of the product.

IRC-6 Operation

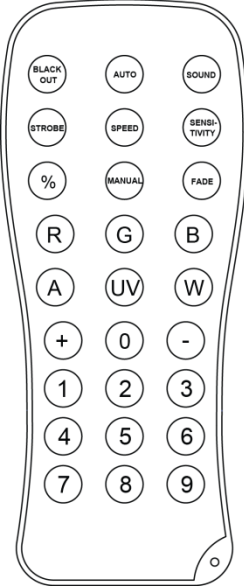

Static Color Mode

Static Color mode will enable the product to output a preset color.

To run Static Color mode:

Press **<0>** – **<9>** to choose between the different preset static colors.

Automatic/Sound-Active Mode

Automatic/Sound-Active mode will enable you to run the automatic programs on the product. The product will also respond to music if the sensitivity knob is set high enough.

To turn on Automatic/Sound-Active mode:

1. Press **<AUTO>** or **<SOUND>** on the IRC.
2. Press **<0>** – **<9>**, or **<FADE>** to choose between the different programs.

To change the auto program speed:

Press **<+>** or **<->** to increase or decrease the auto program speed.

To turn off Automatic/Sound-Active mode and return to Static Color mode:

Press **<AUTO>** or **<SOUND>** on the IRC.

COLORstrip™ IRC-6 Buttons:

Static Color Mode	Auto/Sound Mode
<0> - A007 (White)	<0> - A008
<1> - A001 (Red)	<1> - A009
<2> - A021 (Amber)	<2> - A010
<3> - A004 (Yellow)	<3> - A011
<4> - A002 (Green)	<4> - A012
<5> - A006 (Cyan)	<5> - A013
<6> - A003 (Blue)	<6> - A014
<7> - A005 (Purple)	<7> - A015
<8> - A021 (Pink)	<8> - A017
<9> - A021 (Sunflower)	<9> - A023
<FADE> - No function	<FADE> - A022 (no response to sound)

Manual Color Control

To manually control the RGB percentage:

1. Press **<MANUAL>** on the IRC.
2. Press **<R>** (red), **<G>** (green), or **** (blue) to choose the color.
3. Press **<+>** or **<->** to increase or decrease the percentage of each color.

Miscellaneous Operation

To adjust the strobe rate of the program:

1. Press **<STROBE>** on the IRC.
2. Press **<+>** or **<->** to increase or decrease the strobe rate.
3. Press **<STROBE>** again to turn off the strobe.

To black out the lights:

Press **<BLACK OUT>** on the IRC.

This will turn off all the lights until the button is pressed again.

NOTE: The IRC will not respond to any inputs when Black Out is activated. If the remote does not respond when a button is pressed, try pressing **<BLACK OUT>**. You may have inadvertently activated Black Out.

Master/Slave Mode

The Master/Slave mode allows a single COLORstrip™ product (the “master”) to control the actions of one or more COLORstrip™ products (the “slaves”) without the need of a DMX controller. The master product will be set to operate in either Automatic or Sound-Active mode, while the slave products will be set to operate in Slave mode. Once set and connected, the slave products will operate in unison with the master product.

Configure the products as indicated below.

Slave products:

1. Press **<MODE>** repeatedly until **SYS** or **ACt** shows on the display.
2. Press **<UP>** or **<DOWN>** repeatedly until **SYS** shows on the display.
3. Press **<ENTER>**.
4. Press **<UP>** or **<DOWN>** repeatedly until **SdAd** shows on the display.
5. Press **<ENTER>**, and **001– 508** will show on the display.
6. Set the DMX address to **001**.
7. Connect the DMX input of the first slave product to the DMX output of the master product. **SLA** will show on the display.
8. Connect the DMX input of the subsequent slave products to the DMX output of the previous slave product.
9. Finish setting and connecting all the slave products.

Master product:

1. Set the master product to run in auto or sound mode.
2. Make the master product the first product in the DMX daisy chain.



- **Configure all the slave products before connecting the master to the daisy chain.**
- **Never connect a DMX controller to a DMX string configured for Master/Slave operation because the controller may interfere with the signals from the master.**
- **Do not connect more than 31 slaves to the master.**

Master/Slave Runway Effect

The Master/Slave Runway Effect mode allows a single COLORstrip™ product (the master) to control the actions of one or more COLORstrip™ products (the slaves) in a runway effect without the need of a DMX controller. The master product will be set to operate on specific programs in either Automatic or Sound-Active mode, while the slave products will be set to operate in Slave mode. Once set and connected, the program will run smoothly from product to product.

Configure the products as indicated below.

Slave products:

1. Press **<MODE>** repeatedly until **SYS** or **ACt** shows on the display.
2. Press **<UP>** or **<DOWN>** repeatedly until **SYS** shows on the display.
3. Press **<ENTER>**.
4. Press **<UP>** or **<DOWN>** repeatedly until **SdAd** shows on the display.
5. Press **<ENTER>**, and **001– 508** will show on the display.
6. Set the DMX address to **001**.
7. Connect the DMX input of the subsequent slave products to the Master/Slave output of the previous slave product.
8. Finish setting and connecting all the slave products.

Master product:

1. Set the master product to run in auto or sound mode, **A014–A020**.
2. Connect the DMX input of the first slave product to the Master/Slave output of the master product. **SLA** will show on the displays of the slaves.



- **Configure all the slave products before connecting the master to the daisy chain.**
- **Never connect a DMX controller to a DMX string configured for Master/Slave operation because the controller may interfere with the signals from the master.**
- **Do not connect more than 31 slaves to the master.**

5. MAINTENANCE

Product Maintenance

Dust build-up reduces light output performance and can cause overheating. This can lead to reduction of the light source's life and/or mechanical wear. To maintain optimum performance and minimize wear, clean your lighting products at least twice a month. However, be aware that usage and environmental conditions could be contributing factors to increase the cleaning frequency.

To clean the product, follow the instructions below:

1. Unplug the product from power.
2. Wait until the product is at room temperature.
3. Use a vacuum (or dry compressed air) and a soft brush to remove dust collected on the external surface/vents.
4. Clean all transparent surfaces with a mild soap solution, ammonia-free glass cleaner, or isopropyl alcohol.
5. Apply the solution directly to a soft, lint free cotton cloth or a lens cleaning tissue.
6. Softly drag any dirt or grime to the outside of the transparent surface.
7. Gently polish the transparent surfaces until they are free of haze and lint.



Always dry the transparent surfaces carefully after cleaning them.

6. TECHNICAL SPECIFICATIONS

Dimensions and Weight	Length	Width	Height	Weight
	38 in (965 mm)	2.5 in (64 mm)	6 in (155 mm)	4.5 lb (2 kg)

Note: Dimensions in inches rounded to the nearest decimal digit.

Power	Power Supply Type	Range	Voltage Selection
	Switching (internal)	100 to 240 VAC, 50/60 Hz	Auto-ranging

Parameter	120 V, 60 Hz	230 V, 50 Hz
	Consumption	72 W
Operating Current	0.6 A	0.3 A
Power linking current (products)	8 A (15 products)	8 A (28 products)
Fuse	F 1 A, 250 V	F 1 A, 250 V

Power I/O	U.S./Worldwide	UK/Europe
Power input connector	IEC	IEC
Power output connector	Edison	IEC
Power Cord plug	Edison (U.S.)	Local plug

Light Source	Type	Power	Lifespan
	LED	0.25 W	100,000 hours

Color	Quantity	Current
	Red	128
Green	128	20 mA
Blue	128	20 mA

Photometrics	Parameter	
	Beam Angle	53° x 27°
Field Angle	68° x 46°	
Illuminance @ 2 m	1,104 lux	

Thermal	Maximum External Temp.	Cooling System
	104 °F (40 °C)	Convection

DMX	I/O Connectors	Channel Range
	3-pin XLR	4

Ordering	Product Name	Item Code	UPC Number
	COLORstrip™	10051063	781462214111

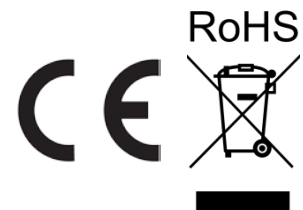

RETURNS

In case you need to get support or return a product:

- If you are located in the U.S., contact Chauvet World Headquarters.
- If you are located in the UK or Ireland, contact Chauvet Europe Ltd.
- If you are located in Mexico, contact Chauvet Mexico.
- If you are located in Benelux, contact Chauvet Europe BVBA.
- If you are located in any other country, DO NOT contact Chauvet. Instead, contact your local distributor. See www.chauvetlighting.com for distributors outside the U.S., UK, Ireland, Mexico, or Benelux.



If you are located outside the U.S., UK, Ireland, Mexico, or Benelux, contact your distributor of record and follow their instructions on how to return Chauvet products to them. Visit our website www.chauvetlighting.com for contact details.

Call the corresponding Chauvet Technical Support office and request a Return Merchandise Authorization (RMA) number before shipping the product. Be prepared to provide the model number, serial number, and a brief description of the cause for the return.

Send the merchandise prepaid, in its original box, and with its original packing and accessories. Chauvet will not issue call tags.

Clearly label the package with the RMA number. Chauvet will refuse any product returned without an RMA number.



Write the RMA number on a properly affixed label. DO NOT write the RMA number directly on the box.

Before sending the product, clearly write the following information on a piece of paper and place it inside the box:

- Your name
- Your address
- Your phone number
- RMA number
- A brief description of the problem

Be sure to pack the product properly. Any shipping damage resulting from inadequate packaging will be your responsibility. FedEx packing or double-boxing are recommended.



Chauvet reserves the right to use its own discretion to repair or replace returned product(s).

CONTACT US

WORLD HEADQUARTERS - Chauvet

General Information

Address: 5200 NW 108th Avenue
Sunrise, FL 33351
Voice: (954) 577-4455
Fax: (954) 929-5560
Toll free: (800) 762-1084

Technical Support

Voice: (954) 577-4455 (Press 4)
Fax: (954) 756-8015
Email: tech@chauvetlighting.com

World Wide Web www.chauvetlighting.com

UNITED KINGDOM AND IRELAND - Chauvet Europe Ltd.

General Information

Address: Unit 1C
Brookhill Road Industrial Estate
Pinxton, Nottingham, UK
NG16 6NT
Voice: +44 (0)1773 511115
Fax: +44 (0)1773 511110

Technical Support

Email: uktech@chauvetlighting.com

World Wide Web www.chauvetlighting.co.uk

MEXICO - Chauvet Mexico

General Information

Address: Av. Santa Ana 30
Parque Industrial Lerma
Lerma, Mexico C.P. 52000
Voice: +52 (728) 285-5000

Technical Support

Email: servicio@chauvet.com.mx

World Wide Web www.chauvet.com.mx

CHAUVET EUROPE - Chauvet Europe BVBA

General Information

Address: Stokstraat 18
9770 Kruishoutem
Belgium
Voice: +32 9 388 93 97

Technical Support

Email: Eutech@chauvetlighting.eu

World Wide Web www.chauvetlighting.eu

Outside the U.S., United Kingdom, Ireland, Mexico, or Benelux contact your dealer. Follow their instructions to request support or to return a product. Visit our website for contact details.