

MegaStrobe™ FX12

User Manual

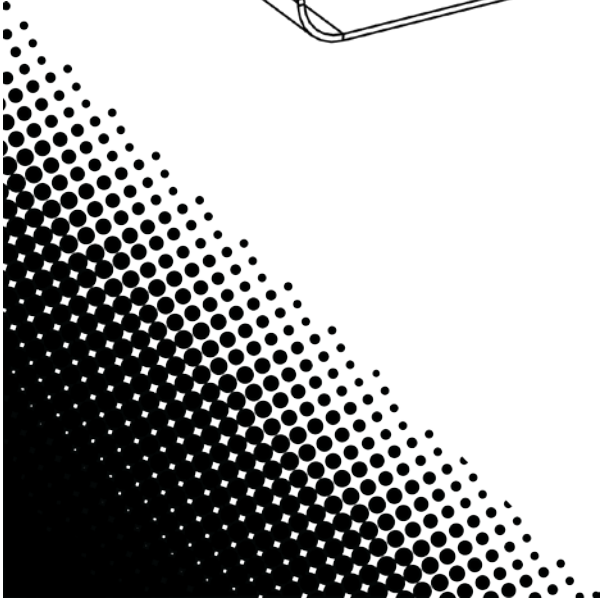
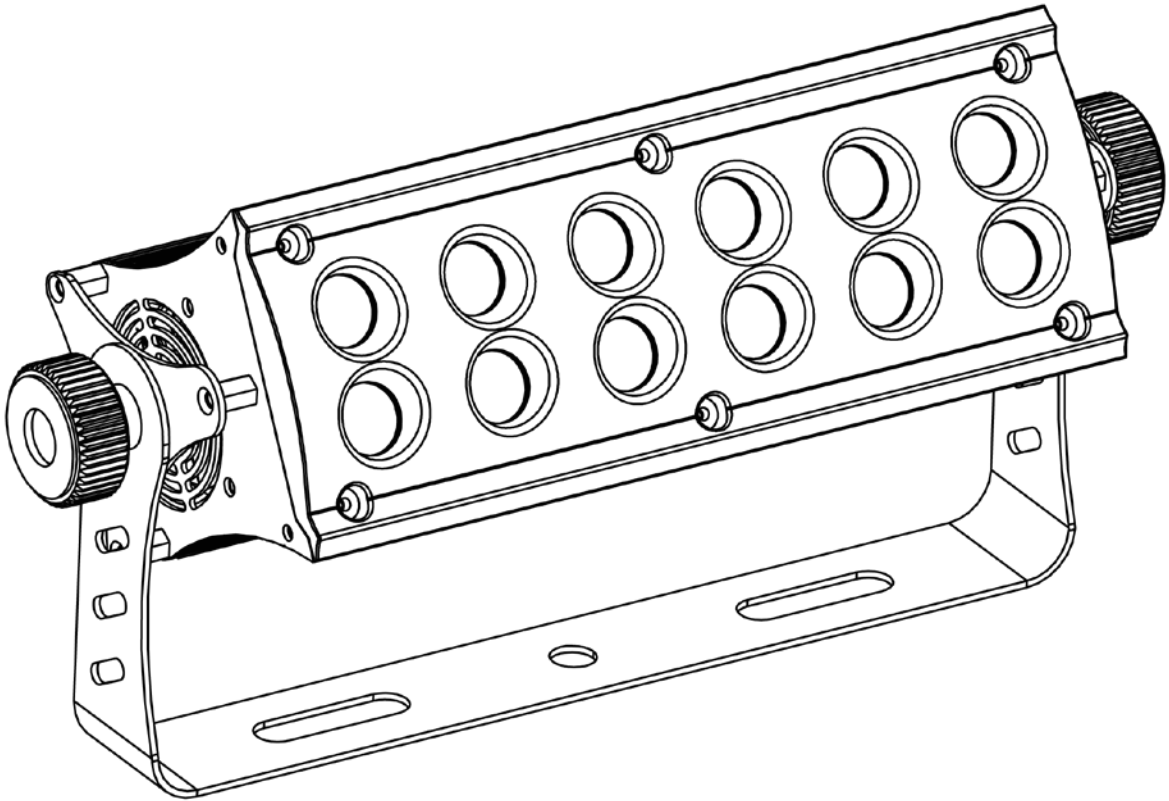

CHAUVET®

TABLE OF CONTENTS

1. Before You Begin	3
What Is Included.....	3
Unpacking Instructions	3
Claims	3
Text Conventions	3
Symbols.....	3
Disclaimer.....	3
Product at a Glance.....	4
Safety Notes.....	4
2. Introduction	5
Overview.....	5
Dimensions.....	6
3. Setup	7
AC Power	7
Fuse Replacement	7
Power Linking.....	8
Mounting.....	9
Orientation.....	9
Rigging	9
4. Operation	10
Control Panel Operation.....	10
Menu Map.....	10
Configuration (DMX).....	11
Starting Address.....	11
DMX Channel Modes, Assignments, and Values	12
2-Channel.....	12
5-Channel.....	12
8-Channel.....	12
Configuration (Standalone)	13
Sound-Active Mode and Sound Sensitivity.....	13
Automatic Mode.....	13
Automatic Program Brightness and Strobe Speed	13
Temperature Display	13
Display Orientation	13
Load Factory Defaults	13
Master/Slave Mode.....	14
5. Technical Information	15
Product Maintenance	15
6. Technical Specifications	16
Returns	17
Contact Us.....	18

1. BEFORE YOU BEGIN

What is Included

- MegaStrobe™ FX12
- Power cord
- Warranty card
- Quick Reference Guide

Unpacking Instructions

Carefully unpack the product immediately and check the container to make sure all the parts are in the package and are in good condition.

Claims



If the box or the contents (the product and included accessories) appear damaged from shipping, or show signs of mishandling, notify the carrier immediately, not CHAUVET®. Failure to report damage to the carrier immediately may invalidate your claim. In addition, keep the box and contents for inspection.

For other issues, such as missing components or parts, damage not related to shipping, or concealed damage, file a claim with CHAUVET® within 7 days of delivery.

Text Conventions

Convention	Meaning
1—512	A range of values
50/60	A set of values of which only one can be chosen
Settings	A menu option not to be modified
Menu > Settings	A sequence of menu options to be followed
<ENTER>	A key to be pressed on the product's control panel
ON	A value to be entered or selected

Symbols

Symbol	Meaning
	Critical installation, configuration, or operation information. Not following these instructions may make the product not work, cause damage to the product, or cause harm to the operator.
	Important installation or configuration information. The product may not function correctly if this information is not used.
	Useful information.

Disclaimer

The information and specifications contained in this user manual are subject to change without notice. CHAUVET® assumes no responsibility or liability for any errors or omissions, and reserves the right to revise or recreate this manual at any time. Download the latest version from www.chauvetlighting.com.

© Copyright 2014 CHAUVET®. All rights reserved.

Electronically published by CHAUVET® in the United States of America.

Author	Date	Editor	Date
A. Leon	01/17/13	L. Henry	01/20/14

Product at a Glance

Use on Dimmer	X	Auto Programs	P
Outdoor Use	X	Auto-ranging Power Supply	P
Sound-Activated	P	Replaceable Fuse	P
DMX	P	User-Serviceable	X
Master/Slave	P		

Safety Notes

These notes include important information about the mounting, usage, and maintenance of this product; read before using the product.



- Always connect the product to a grounded circuit to avoid the risk of electrocution.
- Always disconnect the product from the power source before cleaning or replacing the fuse.
- Avoid direct eye exposure to the light source while the product is on.
- Make sure the power cord is not crimped or damaged.
- Never disconnect the product from power by pulling or tugging on the cord.
- If mounting the product overhead, always secure to a fastening device using a safety cable.
- Make sure there are no flammable materials close to the product when operating.
- Do not touch the product's housing when operating because it may be very hot.



- Always make sure that the voltage of the outlet to which you are connecting the product is within the range stated on the decal or rear panel of the product.
- The product is for indoor use only! (IP20) To prevent risk of fire or shock, do not expose the product to rain or moisture.
- Always install the product in a location with adequate ventilation, at least 20 in (50 cm) from adjacent surfaces.
- Be sure that no ventilation slots on the product's housing are blocked.
- Never connect the product to a dimmer.
- Make sure to replace the fuse with another of the same type and rating.
- Never carry the product from the power cord or any moving part. Always use the hanging/mounting bracket.
- The maximum ambient temperature (Ta) is 104 °F (40 °C). Do not operate the product at higher temperatures.
- In the event of a serious operating problem, stop using the product immediately.
- Never try to repair the product. Repairs carried out by unskilled people can lead to damage or malfunction. Contact the nearest authorized technical assistance center.
- This product is not intended for permanent installation.



- Keep this user manual for future use. If you sell the product to another user, be sure to give this document to the next owner.

2. INTRODUCTION

Overview

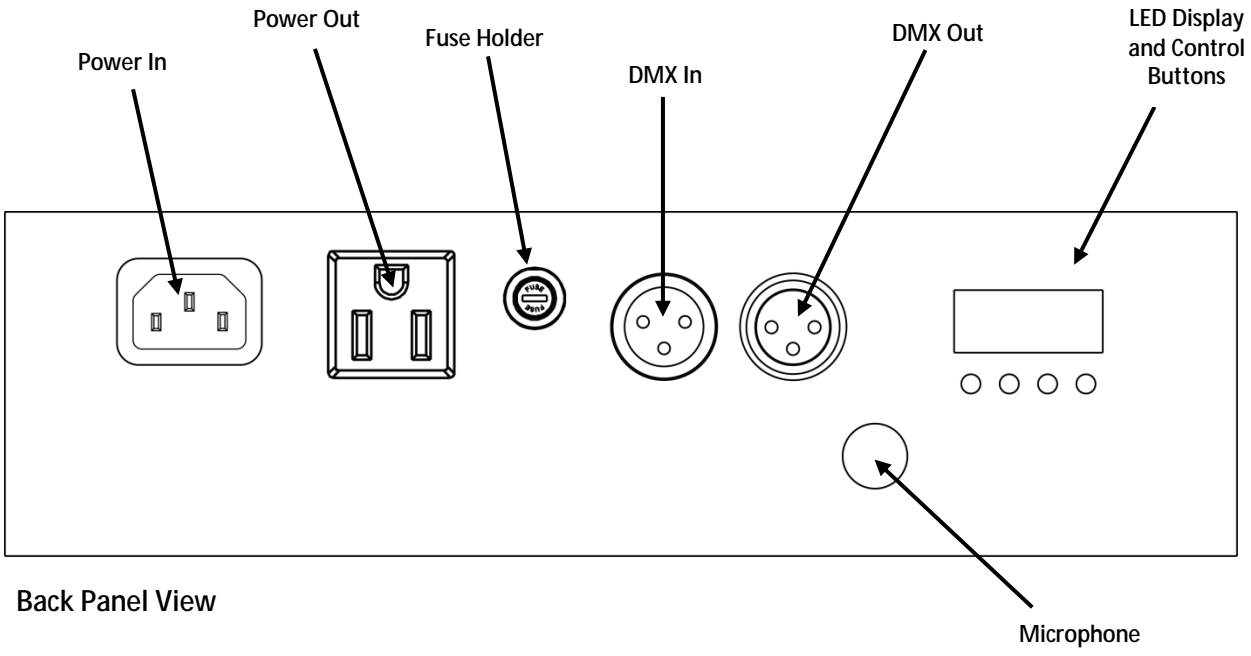

Back Panel View

Dimensions

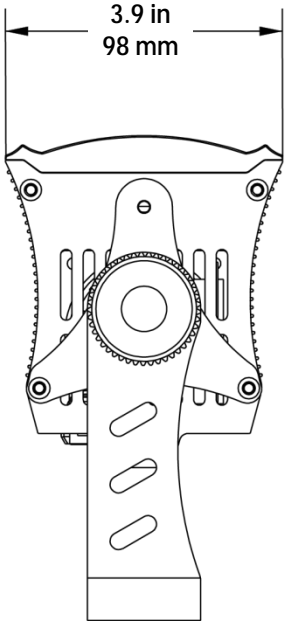
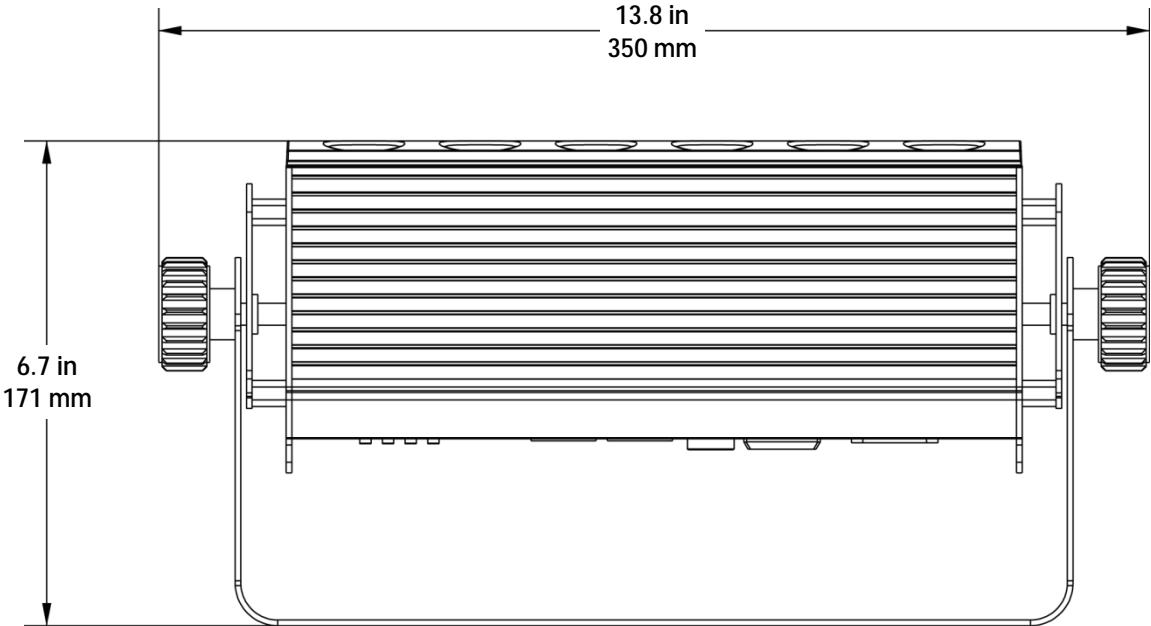

3. SETUP

AC Power The MegaStrobe™ FX12 has an auto-ranging power supply and it can work with an input voltage range of 100 to 240 VAC, 50/60 Hz.

To determine the product's power requirements (circuit breaker, power outlet, and wiring), use the current value listed on the label affixed to the product's back panel, or refer to the product's specifications chart. The listed current rating indicates the product's average current draw under normal conditions.



Always connect the product to a protected circuit (circuit breaker or fuse). Make sure the product has an appropriate electrical ground to avoid the risk of electrocution or fire.



Never connect the product to a rheostat (variable resistor) or dimmer circuit, even if the rheostat or dimmer channel serves only as a 0 to 100% switch.

Fuse Replacement



Disconnect the product from power before replacing the fuse.

1. Disconnect the product from power.
2. With a flat-head screwdriver, unscrew the fuse holder cap from the housing.
3. Remove the blown fuse.
4. Replace with a fuse of the same type and rating.
5. Screw the fuse holder cap back in place and reconnect power.



Always replace a blown fuse with another of the same type and rating.

Power Linking The product provides power linking via the Edison/IEC outlet located in the back of the unit.

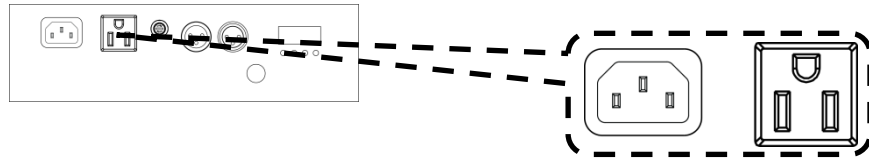

Power Linking Diagram

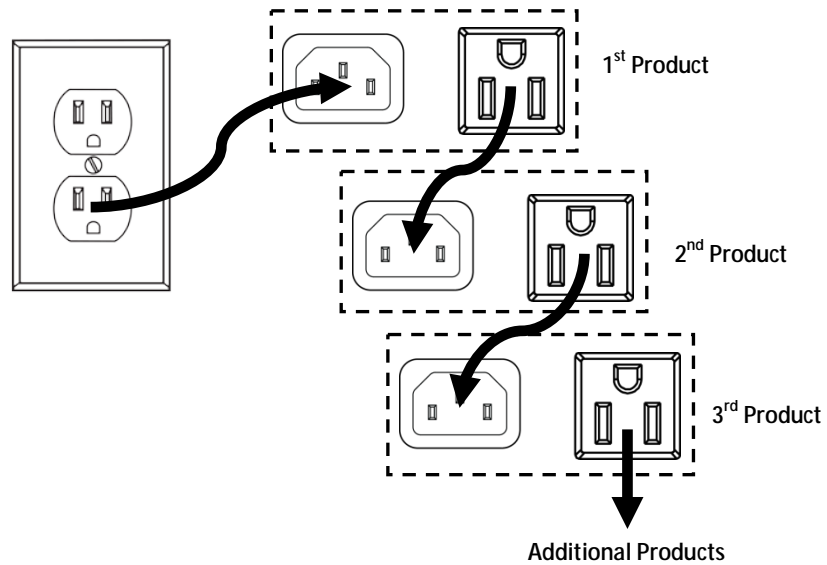

You can power link up to 26 MegaStrobe™ FX12 units on 120 VAC or up to 48 MegaStrobe™ FX12 units on 230 VAC.



The power linking diagram shown above corresponds to the North American version of the product ONLY! If using the product in other markets, you must consult with the local CHAUVET® distributor as power linking connectors and requirements may differ in your country or region.

Mounting Before mounting the product, read and follow the safety recommendations indicated in the Safety Notes.

Orientation The MegaStrobe™ FX12 may be mounted in any position; however, make sure adequate ventilation is provided around the product.

- Rigging**
- Before deciding on a location, always make sure there is easy access to the product for maintenance and programming.
 - Make sure that the structure or surface onto which you are mounting the product can support the product's weight (see [Technical Specifications](#)).
 - When mounting the product overhead, always use a safety cable. Mount the product securely to a rigging point, such as an elevated platform or a truss.
 - When rigging the product onto a truss, you should use a mounting clamp of appropriate weight capacity. The bracket has 13-mm holes, which are appropriate for this purpose.
 - When power linking multiple products, you must always consider the length of the power linking cable and mount the products close enough for the cable to reach.
 - The bracket adjustment knobs allow for directional adjustment when aiming the product to the desired angle. Only loosen or tighten the bracket knobs manually. Using tools could damage the knobs.
 - The mounting bracket also allows for surface mounting. When mounting the product on the floor, make sure that the product and cables are away from people and vehicles.

Mounting Diagram

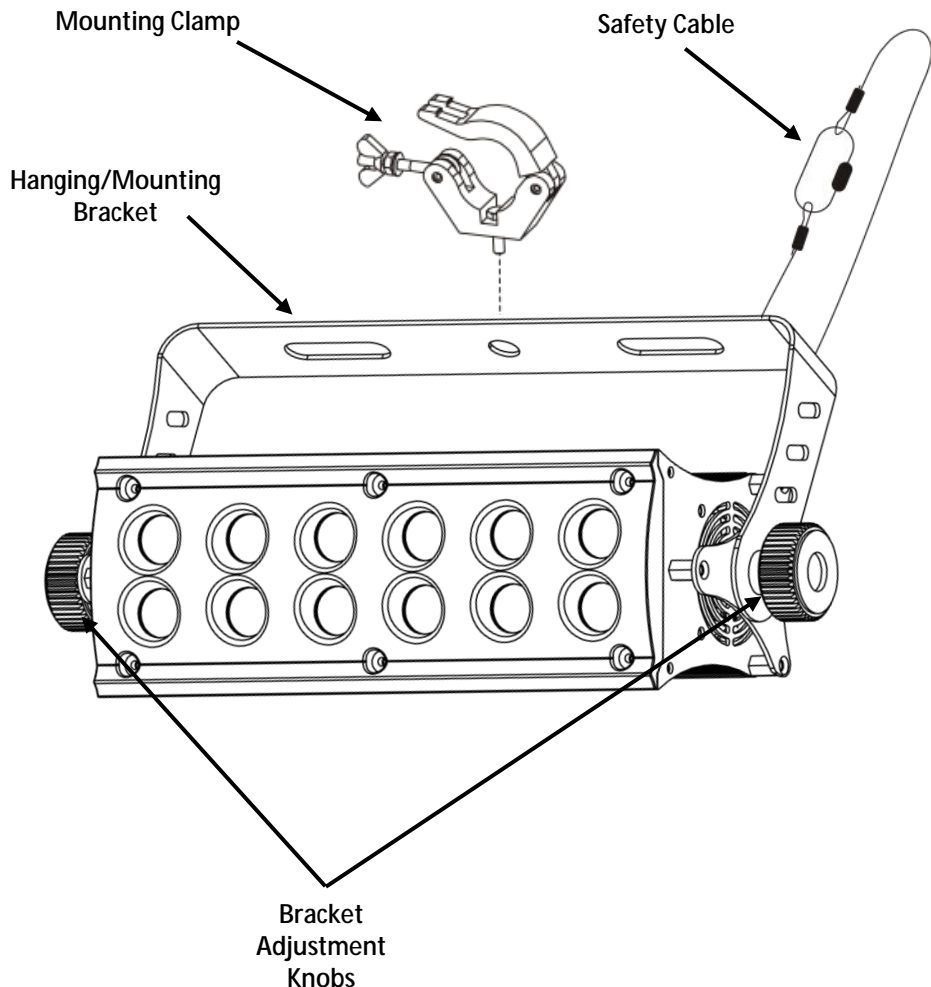

4. OPERATION

Control Panel Operation

To access the control panel functions, use the four buttons located underneath the display.

Button	Function
<MENU>	Selects an operation mode or backs out of the current menu option
<UP>	Scrolls up the list of options or selects a higher value
<DOWN>	Scrolls down the list of options or selects a lower value
<ENTER>	Activates a menu option or a selected value

Menu Map

Main Level	Programming Levels			Description
Starting Address	d__	d001—d512		Selects the DMX starting address
DMX Personality	_CH	2CH		Selects the DMX personality
		5CH		
		8CH		
Auto Program Brightness and Strobe Speed	C000	C000—C255	FS-0—FS-9	Sets the auto program brightness and strobe speed
Automatic Mode	AUtO			Sets auto program
Sound-Active Mode and Sensitivity	SU-	SU-0—SU-8	S-00—S-99	Sets Sound-Active mode and sensitivity
Slave Mode	SLAV			Sets Slave mode
Temperature	tEMP			Temperature display
Inverse Display	diS	diS		Changes the LCD display text position
		rdiS		
Factory Reset	LoAd			Loads factory default settings

Configuration (DMX)

Set the product in DMX mode to control with a DMX controller.

1. Connect the product to a suitable power outlet.
2. Connect a DMX cable from the DMX output of the DMX controller to the DMX input socket on the product.

Starting Address

When selecting a starting DMX address, always consider the number of DMX channels the selected DMX mode uses. If you choose a starting address that is too high, you could restrict the access to some of the product's channels.

The MegaStrobe™ FX12 uses up to 8 DMX channels in its 8-channel DMX mode, which defines the highest configurable address to **505**.

If unfamiliar with DMX, download the DMX Primer from www.chauvetlighting.com.

To select the starting address, do the following:

1. Press **<MENU>** repeatedly until **d001—d512** shows on the display.
2. Press **<ENTER>**.
3. Use **<UP>** or **<DOWN>** to select the starting address.
4. Press **<ENTER>**.

DMX Personalities

The MegaStrobe™ FX12 has three DMX personalities: **2CH** (2-channel personality), **5CH** (5-channel personality), and **8CH** (8-channel personality).

To select a DMX personality, follow the instructions below:

1. Press **<MENU>** repeatedly until **2CH**, **5CH**, or **8CH** shows on the display.
2. Use **<UP>** or **<DOWN>** to select the desired DMX personality.
3. Press **<ENTER>**.

DMX Channel Modes, Assignments, and Values

2-Channel	Channel	Function	Value	Setting
1	Shutter	000 ó 003	No function	
		004 ó 255	0 to 100% (slow to fast)	
2	Dimmer	000 ó 255	0 to 100%	

5-Channel	Channel	Function	Value	Setting
1	Dimmer	000 ó 255	0 to 100%	
2	Shutter	000 ó 015	No function	
		016 ó 032	Sound control shutter	
		033 ó 049	Pulse strobe	
		050 ó 066	Slow on, fast off	
		067 ó 083	Fast on, slow off	
		084 ó 100	Slow on, slow off	
		101 ó 117	Strobe slow on, slow off	
		118 ó 134	Shutter	
		135 ó 151	Pulse strobe 1	
		152 ó 168	Pulse strobe 2	
		169 ó 185	Slow on, fast off	
		186 ó 202	Fast on, slow off	
		203 ó 219	Slow on, slow off	
		220 ó 236	Strobe slow on, slow off	
		237 ó 255	Shutter	
3	Shutter Speed	000 ó 255	0 to 100% (when Ch. 2 is 033–255) (Sound sensitivity when Ch. 2 is 016–032)	
4	Pixels	000 ó 255	Pixel control	
		000 ó 255	Auto program speed (when Ch. 5 is 049–240)	
		000 ó 255	Sound sensitivity (when Ch. 5 is 241–255)	
5	Auto Programs	000 ó 048	No function	
		049 ó 064	Auto program 1	
		065 ó 080	Auto program 2	
		081 ó 096	Auto program 3	
		097 ó 112	Auto program 4	
		113 ó 128	Auto program 5	
		129 ó 144	Auto program 6	
		145 ó 160	Auto program 7	
		161 ó 176	Auto program 8	
		177 ó 192	Auto program 9	
		193 ó 208	Auto program 10	
		209 ó 224	Auto program 11	
		225 ó 240	Auto program 12	
		241 ó 255	Sound-Active	

8-Channel	Channel	Function	Value	Setting
1	Dimmer	000 ó 255	0 to 100%	
2	Dimmer	000 ó 255	0 to 100%	
3	Dimmer	000 ó 255	0 to 100%	
4	Dimmer	000 ó 255	0 to 100%	
5	Dimmer	000 ó 255	0 to 100%	
6	Dimmer	000 ó 255	0 to 100%	
7	Shutter Effects	000 ó 255	0 to 100%	
8	Shutter Effects Speed	000 ó 255	0 to 100%	

Configuration (Standalone)

Set the product in one of the standalone modes to control without a DMX controller.

- Connect the product to a suitable power outlet.



Never connect a product that is operating in any standalone mode (Static, Automatic, or Sound-Active) to a DMX string connected to a DMX controller. Products in standalone mode may transmit DMX signals that could interfere with the DMX signals from the controller.

Sound-Active Mode and Sound Sensitivity

To enable the Sound-Active mode and set sound sensitivity, do the following:

1. Press **<MENU>** repeatedly until **SU-0—SU-8** (Sound-Active modes 1—8) shows on the display.
2. Use **<UP>** or **<DOWN>** to select the desired Sound-Active mode.
3. Press **<ENTER>**.
4. Use **<UP>** or **<DOWN>** to select **S-00—S-99** (sound sensitivity).
5. Press **<ENTER>**.



The product will only respond to low frequencies of music (bass and drums).

Automatic Mode

To enable the Automatic mode, follow the instructions below:

1. Press **<MENU>** repeatedly until **AUTO** shows on the display.
2. Press **<ENTER>**.

Automatic Program Brightness and Strobe Speed

To set the automatic program brightness and strobe speed, do the following:

1. Press **<MENU>** repeatedly until **C000—C255** (auto program brightness) shows on the display.
2. Use **<UP>** or **<DOWN>** to select the desired brightness.
3. Press **<ENTER>**.
4. Use **<UP>** or **<DOWN>** to select **FS 0—FS 9** (auto program strobe speed).
5. Press **<ENTER>**.

Temperature Display

To view the temperature of the LEDs, follow the instructions below:

1. Press **<MENU>** repeatedly until **tEMP** shows on the display.
2. Press **<ENTER>** and the temperature will be shown in degrees Celsius.

Display Orientation

You are able to flip the LED display for easy readability in any mounting situation.

To select your display angle:

1. Press **<MENU>** repeatedly until **diS** (normal) or **rdiS** (inverted) shows on the display.
2. Use **<UP>** or **<DOWN>** to select the desired orientation.
3. Press **<ENTER>**.

Load Factory Defaults

To load the factory default settings in the MegaStrobe™ FX12, follow the instructions below:

1. Press **<MENU>** and until **LoAd** shows on the display.
2. Press **<ENTER>**.

Master/Slave Mode

The Master/Slave mode allows a single MegaStrobe™ FX12 unit (the “master”) to control the actions of one or more MegaStrobe™ FX12 units (the “slaves”) without the need of a DMX controller. The master unit will be set to operate in either Automatic or Sound-Active mode, while the slave units will be set to operate in Slave mode. Once set and connected, the slave units will operate in unison with the master unit.

Configure the units as indicated below.

Slave units:

1. Press **<MENU>** repeatedly until **SLAV** shows on the display.
2. Press **<ENTER>** to accept.
3. Connect the DMX input of the first slave unit to the DMX output of the master unit.
4. Connect the DMX input of the subsequent slave units to the DMX output of the previous slave unit.
5. Finish setting and connecting all the slave units.

Master unit:

1. Set the master unit to operate in either Automatic or Sound-Active mode.
2. Make the master unit the first unit in the DMX daisy chain.



- Configure all the slave units before connecting the master unit to the DMX daisy chain.
- Never connect a DMX controller to a DMX string configured for Master/Slave operation because the controller may interfere with the signals from the master unit.
- Do not connect more than 31 slave units to the master unit.

5. TECHNICAL INFORMATION

Product Maintenance

Dust build-up reduces light output performance and can cause overheating. This can lead to reduction of the light source's life and mechanical wear. To maintain optimum performance and minimize wear, clean the product at least twice a month. However, usage and environmental conditions contribute to increased cleaning frequency.

To clean the product, follow the instructions below:

1. Unplug the product from power.
2. Wait until the product is at room temperature.
3. Use a vacuum (or dry compressed air) and a soft brush to remove dust collected on the external surface and vents.
4. Clean all external optics and glass/transparent surfaces with a mild soap solution, ammonia-free glass cleaner, or isopropyl alcohol.
5. Apply the solution directly to a soft, lint-free cotton cloth or a lens cleaning tissue.
6. Softly wipe any dirt or grime to the outside edges of the external optics or glass/transparent surface.
7. Gently polish the external optics and glass/transparent surfaces until they are free of haze and lint.



Always dry the external optics and glass/transparent surfaces carefully after cleaning them.



Do not spin the cooling fan using compressed air because you could damage it.

6. TECHNICAL SPECIFICATIONS

Dimensions and Weight	Length	Width	Height	Weight
	13.8 in (350 mm)	3.9 in (98 mm)	6.7 in (171 mm)	4.1 lb (1.9 kg)
Note: Dimensions in inches rounded to the nearest decimal digit.				
Power	Power Supply Type	Range	Voltage Selection	
	Switching (internal)	100 to 240 VAC, 50/60 Hz	Auto-ranging	
	Parameter	120 V, 60 Hz	230 V, 50 Hz	
	Consumption	63 W	66 W	
	Operating current	0.5 A	0.3 A	
Power I/O	Power I/O	US/Worldwide	UK/Europe	
	Power input connector	IEC	IEC	
	Power output connector	Edison	IEC	
	Power Cord plug	Edison (US)	Local plug	
	Power linking current (units)	8 A (26 units)	8 A (48 units)	
Light Source	Fuse	F 2 A, 250 V	F 2 A, 250 V	
	Type	Power	Lifespan	
	LED	3 W	50,000 hours	
	Color	Quantity	Current	
	White	12	700 mA	
Photo Optic	Parameter			
	Illuminance @ 2 m	2186 lx		
	Beam angle	20°		
	Field angle	38°		
	Strobe rate	0 to 26 Hz		
Thermal	Maximum External Temp.	Cooling System		
	104 °F (40 °C)	Fan-cooled		
DMX	I/O Connectors	Connector Type	Channel Range	
	3-pin XLR	Sockets	2, 5, 8	
Ordering	Product Name	Item Code	Item Number	
	MegaStrobe™ FX12	08050551	781462208998	

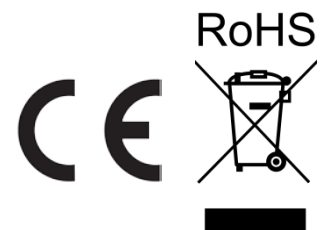

To return a product or request support:

- In the U.S., contact CHAUVET® World Headquarters (see below).
- In the UK or Ireland, contact CHAUVET® Europe Ltd. (see below).
- In any other country, DO NOT contact CHAUVET®. Contact your distributor. See www.chauvetlighting.com for distributors outside the U.S., United Kingdom, or Ireland.



If you live outside the U.S., United Kingdom, or Ireland, contact your distributor of record and follow their instructions on how to return CHAUVET® products to them. Visit our website for contact details.

Returns

Call the corresponding CHAUVET® Technical Support office and request a Return Merchandise Authorization (RMA) number before shipping the product. Be prepared to provide the model number, serial number, and a brief description of the cause for the return.

You must send the merchandise prepaid, in its original box, and with its original packing and accessories. CHAUVET® will not issue call tags.

Clearly label the package with the RMA number. CHAUVET® will refuse any product returned without an RMA number.



Write the RMA number on a properly affixed label. DO NOT write the RMA number directly on the box.

Before sending the product, clearly write the following information on a piece of paper and place it inside the box:

- Your name
- Your address
- Your phone number
- RMA number
- A brief description of the problem

Be sure to pack the product properly. Any shipping damage resulting from inadequate packaging will be your responsibility. FedEx packing or double-boxing are recommended.



CHAUVET® reserves the right to use its own discretion to repair or replace returned product(s).

Contact Us

WORLD HEADQUARTERS - CHAUVET®

General Information

Address: 5200 NW 108th Avenue
Sunrise, FL 33351
Voice: (954) 577-4455
Fax: (954) 929-5560
Toll free: (800) 762-1084

Technical Support

Voice: (954) 577-4455 (Press 4)
Fax: (954) 756-8015
Email: tech@chauvetlighting.com

World Wide Web www.chauvetlighting.com

UNITED KINGDOM AND IRELAND - CHAUVET® Europe Ltd.

General Information

Address: Unit 1C
Brookhill Road Industrial Estate
Pinxton, Nottingham, UK
NG16 6NT
Voice: +44 (0)1773 511115
Fax: +44 (0)1773 511110

Technical Support

Email: uktech@chauvetlighting.com

World Wide Web www.chauvetlighting.co.uk

MEXICO - CHAUVET® Mexico

General Information

Address: Av. Santa Ana 30
Parque Industrial Lerma
Lerma, Mexico C.P. 52000
Voice: +52 (728) 285-5000

Technical Support

Email: servicio@chauvet.com.mx

World Wide Web www.chauvet.com.mx

Outside the U.S., United Kingdom, Ireland, or Mexico, contact your dealer. Follow their instructions to request support or to return a product. Visit our website for contact details.